



PRODUCT CATALOGUE

Vol. 13.0

Experience the Clover difference.



CLOVER MFG. CO.,LTD.

Clover manufactures products that are safe and reliable from the customers' perspective, and which are also environmentally friendly.



Clover's quality policy

- We maximize our corporate value by manufacturing products that satisfy and resonate with customers.
- We reflect customers' demands and expectations into product manufacturing.
- We actively respond to environmental issues under our motto of being a company that is friendly to people and the environment.



Our symbol of commitment to quality

- Origin of our Clover Mark -

When Toshio Okada, the founder of Clover Mfg. Co., Ltd., started to work for a needle wholesaler in Osaka at the age of 14, his mentor gave him a textbook on moral philosophy. As a bookmark for this book, Toshio used a clover leaf grown in his hometown. In 1925, he opened his own shop, and soon after World War II, began manufacturing products on a full scale to provide consumers with needles and sewing tools. That was when he decided to use the design of the clover leaf—sandwiched between the pages of a book he had when he left home—as a mark to assure product quality. Although needles are small items, they are essential to people's daily life, just like water and salt. The Clover Mark continues to represent the founder's philosophy of assuring quality and taking responsibility for even the smallest products the company offers.

Clover's environmental initiatives Obtained ISO 14001 certification



ISO 14001 certified
Clover Mfg. Co., Ltd.
Higashiosaka Office

Clover's Higashiosaka Office (including Osaka Factory and Central Distribution Center) acquired the international ISO 14001 environmental standard in 2000. The office acquired the certification again in June 2008 following its relocation and completion of the renewal procedure.

Contents



Bamboo Knitting Needles Takumi [®]	4
Crochet Hooks	16
Knitting Accessories	21
Black Gold Needles	31
Sewing, Quilting & Embroidery Needles	33
Pins	36
Thimbles	39
Sewing Notions	41
Marking Tools	43
Sewing & Patchwork Accessories	48
Wonder Clips	64
Slash Cutter	67
Scissors	68
Rotary Cutters	69
Tape Makers	71
Mini Iron & Accessories	73
Embroidery Stitching Tools	74
" <i>Kantan Couture</i> " Bead Embroidery Tools	75
Swift Bead	76
Stitch Dome	76
"QUICK" Yo-Yo Makers	77
Kanzashi Flower Makers	78
Wonder Knitter	79
French Knitter	79
Flower Loom	80
Bracelet Maker	80
Pom-Pom Makers	81
Tassel Makers	82
Hair Pin Lace Tool	83
Needle Felting Tools	83
Natural Wool Rovings	84
Tatting Shuttles	85
Picot Gauge Set	85
Mini Weaving Looms	86
Beading Loom	87
Rosette Makers	88



Bamboo Knitting Needles Takumi®

The art born from combining the finest raw materials and Clover's unmatched manufacturing technology.

Each and every one of these high quality bamboo knitting needles has been created utilising the properties of the finest natural materials.

Takumi Bamboo Knitting Needles have been created with Clover's long-nurtured manufacturing technology which maximizes the qualities of the finest natural bamboo to achieve even a smoother, heartfelt knitting experience. Their smooth surface and comfortable fitting are the result of Clover's consideration for knitters. You will still be able to find these needles comfortable even after long hours of knitting. Feel and experience these knitting needles made of carefully selected natural bamboo.

Takumi's supreme quality also comes from Clover's excellent manufacturing technology

- **Excellent durability**
Only the finest parts of natural bamboo are used for knitting needles that perform year after year
- **Clover's original, ideally shaped needle tip.**
Takumi Needles are comfortable to hold and will keep your yarn from splitting.
- **Uniform shaft**
These needles feature a special finish that make shafts even—promising neat stitches and finishing.
- **Smooth surface finish**
The surface is carefully finished to fit your hand comfortably and to make sure that yarn glides smoothly along the needles.

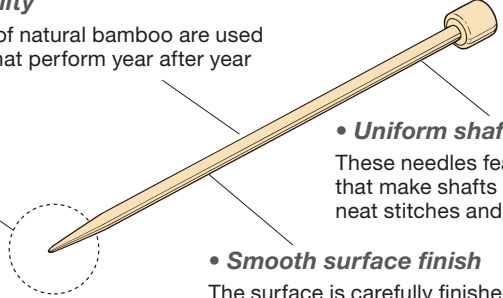

Bamboo that becomes Takumi®

Finest Top Quality Material



Bamboo is a strong, elastic and hardy fiber. Its smooth surface and comfortable fit are the most desirable for knitting needles. Only the most premium parts of the bamboo are used for the needles.

Place of origin is limited to cold areas with little snow. Bamboo in cold areas with little snow is very resistant to bending making this bamboo most desirable for knitting needles. Heavy snow conditions result in bent bamboo.

Appropriately aged Bamboo is selected. Young bamboo less than 3 years old is too soft while bamboo older than 5 years is too fragile. 4 to 5 year old bamboo is the most durable bamboo to use.

Cutting period is limited to winter. Bamboo in winter has less moisture and the fiber is more compact.

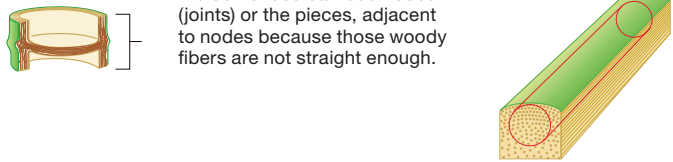
- We do not use bamboo nodes (joints) or the pieces, adjacent to nodes because those woody fibers are not straight enough.
- We use only those bamboo sections between nodes (internodes) that have adequate density.
- We cut and discard the bent portions, shoots and roots of bamboo trees.
- In order to make sure that materials do not shrink when they are dried, we use only the portion near the outer surface, where wood fiber texture is firm and tight.

Needle size (mm) Actual size

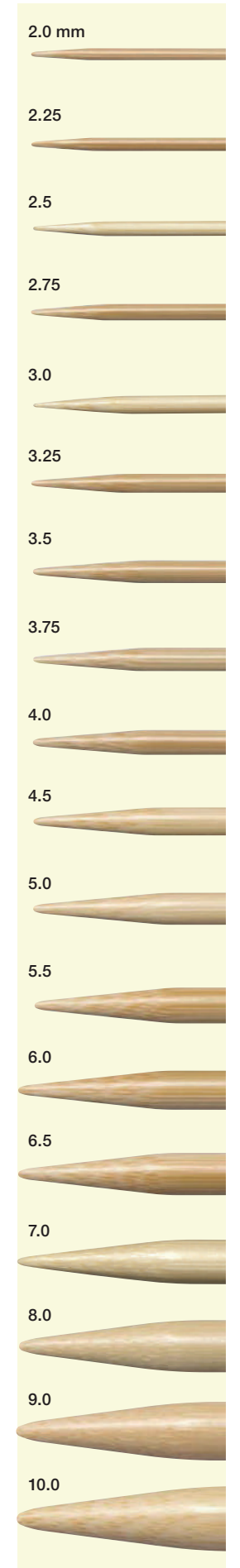

Bamboo Knitting Needles Takumi®

Bamboo Circular Knitting Needles Takumi®

- The newly designed precision tips on **Takumi®** circular knitting needles accommodate the finest yarns and virtually any knitting technique.
- The newly designed connecting cords are smooth and soft, lying flat as you knit.
- The connection between the cord and the knitting needle are seamless allowing the smooth glide of yarn from one surface to the other.



3981-3998	
Bamboo Circular Knitting Needles Takumi® (120 cm)	
Packing	1 pc./pack 3 packs/box
Package Size	9 x 23 x 0.3 - 1.1 cm

3981	120 cm/2.00 mm
4 901316 839819	

3987	120 cm/3.50 mm
4 901316 839871	

3993	120 cm/6.00 mm
4 901316 839932	

3982	120 cm/2.25 mm
4 901316 839826	

3988	120 cm/3.75 mm
4 901316 839888	

3994	120 cm/6.50 mm
4 901316 839949	

3983	120 cm/2.50 mm
4 901316 839833	

3989	120 cm/4.00 mm
4 901316 839895	

3995	120 cm/7.00 mm
4 901316 839956	

3984	120 cm/2.75 mm
4 901316 839840	

3990	120 cm/4.50 mm
4 901316 839901	

3996	120 cm/8.00 mm
4 901316 839963	

3985	120 cm/3.00 mm
4 901316 839857	

3991	120 cm/5.00 mm
4 901316 839918	

3997	120 cm/9.00 mm
4 901316 839970	

3986	120 cm/3.25 mm
4 901316 839864	

3992	120 cm/5.50 mm
4 901316 839925	

3998	120 cm/10.00 mm
4 901316 839987	



Bamboo Knitting Needles Takumi®

Bamboo Circular Knitting Needles Takumi®



3951-3968	
Bamboo Circular Knitting Needles Takumi® (100 cm)	
Packing	1 pc./pack 3 packs/box
Package Size	9 x 23 x 0.3 - 1.1 cm



3921-3938	
Bamboo Circular Knitting Needles Takumi® (80 cm)	
Packing	1 pc./pack 3 packs/box
Package Size	9 x 23 x 0.3 - 1.1 cm

3951 100 cm/2.00 mm

4 901316 839512

3960 100 cm/4.50 mm

4 901316 839604

3921 80 cm/2.00 mm

4 901316 839215

3930 80 cm/4.50 mm

4 901316 839307

3952 100 cm/2.25 mm

4 901316 839529

3961 100 cm/5.00 mm

4 901316 839611

3922 80 cm/2.25 mm

4 901316 839222

3931 80 cm/5.00 mm

4 901316 839314

3953 100 cm/2.50 mm

4 901316 839536

3962 100 cm/5.50 mm

4 901316 839628

3923 80 cm/2.50 mm

4 901316 839239

3932 80 cm/5.50 mm

4 901316 839321

3954 100 cm/2.75 mm

4 901316 839543

3963 100 cm/6.00 mm

4 901316 839635

3924 80 cm/2.75 mm

4 901316 839246

3933 80 cm/6.00 mm

4 901316 839338

3955 100 cm/3.00 mm

4 901316 839550

3964 100 cm/6.50 mm

4 901316 839642

3925 80 cm/3.00 mm

4 901316 839253

3934 80 cm/6.50 mm

4 901316 839345

3956 100 cm/3.25 mm

4 901316 839567

3965 100 cm/7.00 mm

4 901316 839659

3926 80 cm/3.25 mm

4 901316 839260

3935 80 cm/7.00 mm

4 901316 839352

3957 100 cm/3.50 mm

4 901316 839574

3966 100 cm/8.00 mm

4 901316 839666

3927 80 cm/3.50 mm

4 901316 839277

3936 80 cm/8.00 mm

4 901316 839369

3958 100 cm/3.75 mm

4 901316 839581

3967 100 cm/9.00 mm

4 901316 839673

3928 80 cm/3.75 mm

4 901316 839284

3937 80 cm/9.00 mm

4 901316 839376

3959 100 cm/4.00 mm

4 901316 839598

3968 100 cm/10.00 mm

4 901316 839680

3929 80 cm/4.00 mm

4 901316 839291

3938 80 cm/10.00 mm

4 901316 839383

Bamboo Knitting Needles Takumi®

Bamboo Circular Knitting Needles Takumi®



3891-3908	
Bamboo Circular Knitting Needles Takumi® (60 cm)	
Packing	1 pc./pack 3 packs/box
Package Size	9 x 23 x 0.3 - 1.1 cm



3861-3878	
Bamboo Circular Knitting Needles Takumi® (40 cm)	
Packing	1 pc./pack 3 packs/box
Package Size	9 x 23 x 0.3 - 1.1 cm

3891 60 cm/2.00 mm

4 901316 838911

3900 60 cm/4.50 mm

4 901316 839000

3861 40 cm/2.00 mm

4 901316 838614

3870 40 cm/4.50 mm

4 901316 838706

3892 60 cm/2.25 mm

4 901316 838928

3901 60 cm/5.00 mm

4 901316 839017

3862 40 cm/2.25 mm

4 901316 838621

3871 40 cm/5.00 mm

4 901316 838713

3893 60 cm/2.50 mm

4 901316 838935

3902 60 cm/5.50 mm

4 901316 839024

3863 40 cm/2.50 mm

4 901316 838638

3872 40 cm/5.50 mm

4 901316 838720

3894 60 cm/2.75 mm

4 901316 838942

3903 60 cm/6.00 mm

4 901316 839031

3864 40 cm/2.75 mm

4 901316 838645

3873 40 cm/6.00 mm

4 901316 838737

3895 60 cm/3.00 mm

4 901316 838959

3904 60 cm/6.50 mm

4 901316 839048

3865 40 cm/3.00 mm

4 901316 838652

3874 40 cm/6.50 mm

4 901316 838744

3896 60 cm/3.25 mm

4 901316 838966

3905 60 cm/7.00 mm

4 901316 839055

3866 40 cm/3.25 mm

4 901316 838669

3875 40 cm/7.00 mm

4 901316 838751

3897 60 cm/3.50 mm

4 901316 838973

3906 60 cm/8.00 mm

4 901316 839062

3867 40 cm/3.50 mm

4 901316 838676

3876 40 cm/8.00 mm

4 901316 838768

3898 60 cm/3.75 mm

4 901316 838980

3907 60 cm/9.00 mm

4 901316 839079

3868 40 cm/3.75 mm

4 901316 838683

3877 40 cm/9.00 mm

4 901316 838775

3899 60 cm/4.00 mm

4 901316 838997

3908 60 cm/10.00 mm

4 901316 839086

3869 40 cm/4.00 mm

4 901316 838690

3878 40 cm/10.00 mm

4 901316 838782



Bamboo Knitting Needles Takumi®

Bamboo Knitting Needles Takumi® Double Pointed



3791-3804	
Bamboo Knitting Needles Takumi® Double Pointed (12.5 cm)	
Packing	5 pcs./pack 3 packs/box
Package Size	4.5 x 18 x 0.3 - 0.7 cm



3811-3824	
Bamboo Knitting Needles Takumi® Double Pointed (16 cm)	
Packing	5 pcs./pack 3 packs/box
Package Size	4.5 x 21 x 0.3 - 0.7 cm

3791	2.00 mm
4 901316 837914	

3798	3.75 mm
4 901316 837983	

3811	2.00 mm
4 901316 838119	

3818	3.75 mm
4 901316 838188	

3792	2.25 mm
4 901316 837921	

3799	4.00 mm
4 901316 837990	

3812	2.25 mm
4 901316 838126	

3819	4.00 mm
4 901316 838195	

3793	2.50 mm
4 901316 837938	

3800	4.50 mm
4 901316 838003	

3813	2.50 mm
4 901316 838133	

3820	4.50 mm
4 901316 838201	

3794	2.75 mm
4 901316 837945	

3801	5.00 mm
4 901316 838010	

3814	2.75 mm
4 901316 838140	

3821	5.00 mm
4 901316 838218	

3795	3.00 mm
4 901316 837952	

3802	5.50 mm
4 901316 838027	

3815	3.00 mm
4 901316 838157	

3822	5.50 mm
4 901316 838225	

3796	3.25 mm
4 901316 837969	

3803	6.00 mm
4 901316 838034	

3816	3.25 mm
4 901316 838164	

3823	6.00 mm
4 901316 838232	

3797	3.50 mm
4 901316 837976	

3804	6.50 mm
4 901316 838041	

3817	3.50 mm
4 901316 838171	

3824	6.50 mm
4 901316 838249	

Bamboo Knitting Needles Takumi®

Bamboo Knitting Needles Takumi® Double Pointed



3831-3848	
Bamboo Knitting Needles Takumi® Double Pointed (20 cm)	
Packing	5 pcs./pack 3 packs/box
Package Size	
2.0 - 6.5 mm	4.5 x 25.5 x 0.3 - 0.7 cm
7.0 - 10.0 mm	4.5 x 25.8 x 0.8 - 1.1 cm



3831	2.00 mm
4 901316 838317	

3832	2.25 mm
4 901316 838324	

3833	2.50 mm
4 901316 838331	

3834	2.75 mm
4 901316 838348	

3835	3.00 mm
4 901316 838355	

3836	3.25 mm
4 901316 838362	

3837	3.50 mm
4 901316 838379	

3838	3.75 mm
4 901316 838386	

3839	4.00 mm
4 901316 838393	

3840	4.50 mm
4 901316 838409	

3841	5.00 mm
4 901316 838416	

3842	5.50 mm
4 901316 838423	

3843	6.00 mm
4 901316 838430	

3844	6.50 mm
4 901316 838447	

3845	7.00 mm
4 901316 838454	

3846	8.00 mm
4 901316 838461	

3847	9.00 mm
4 901316 838478	

3848	10.00 mm
4 901316 838485	



Bamboo Knitting Needles Takumi®

Bamboo Knitting Needles Takumi® Single Pointed



3765-3778	
Bamboo Knitting Needles Takumi® Single Pointed (40 cm)	
Packing	2 pcs./pack 3 packs/box
Package Size	
3.0 - 6.5 mm	5.5 x 47 x 1.0 - 1.2 cm
7.0 - 10.0 mm	6 x 47 x 1.4 - 1.6 cm



3731-3748	
Bamboo Knitting Needles Takumi® Single Pointed (33 / 35 cm)	
Packing	2 pcs./pack 3 packs/box
Package Size	
2.0 - 6.5 mm	4.5 x 39 x 1.0 - 1.2 cm
7.0 - 10.0 mm	5 x 41.5 x 1.4 - 1.5 cm

3765	3.00 mm
4 901316 837655	

3772	5.50 mm
4 901316 837723	

3731	2.00 mm
4 901316 837310	

3740	4.50 mm
4 901316 837402	

3766	3.25 mm
4 901316 837662	

3773	6.00 mm
4 901316 837730	

3732	2.25 mm
4 901316 837327	

3741	5.00 mm
4 901316 837419	

3767	3.50 mm
4 901316 837679	

3774	6.50 mm
4 901316 837747	

3733	2.50 mm
4 901316 837334	

3742	5.50 mm
4 901316 837426	

3768	3.75 mm
4 901316 837686	

3775	7.00 mm
4 901316 837754	

3734	2.75 mm
4 901316 837341	

3743	6.00 mm
4 901316 837433	

3769	4.00 mm
4 901316 837693	

3776	8.00 mm
4 901316 837761	

3735	3.00 mm
4 901316 837358	

3744	6.50 mm
4 901316 837440	

3770	4.50 mm
4 901316 837709	

3777	9.00 mm
4 901316 837778	

3736	3.25 mm
4 901316 837365	

3745	7.00 mm
4 901316 837457	

3771	5.00 mm
4 901316 837716	

3778	10.00 mm
4 901316 837785	

3737	3.50 mm
4 901316 837372	

3746	8.00 mm
4 901316 837464	

3738	3.75 mm
4 901316 837389	

3747	9.00 mm
4 901316 837471	

3739	4.00 mm
4 901316 837396	

3748	10.00 mm
4 901316 837488	

Bamboo Knitting Needles Takumi®

Bamboo Knitting Needles Takumi® Single Pointed



3701-3718	
Bamboo Knitting Needles Takumi® Single Pointed (23 cm)	
Packing	2 pcs./pack 3 packs/box
Package Size	
2.0 - 6.5 mm	4.5 x 29 x 1.0 - 1.2 cm
7.0 - 10.0 mm	5 x 29 x 1.4 - 1.5 cm

3701	2.00 mm
4 901316 837013	

3702	2.25 mm
4 901316 837020	

3703	2.50 mm
4 901316 837037	

3704	2.75 mm
4 901316 837044	

3705	3.00 mm
4 901316 837051	

3706	3.25 mm
4 901316 837068	

3707	3.50 mm
4 901316 837075	

3708	3.75 mm
4 901316 837082	

3709	4.00 mm
4 901316 837099	

3710	4.50 mm
4 901316 837105	

3711	5.00 mm
4 901316 837112	

3712	5.50 mm
4 901316 837129	

3713	6.00 mm
4 901316 837136	

3714	6.50 mm
4 901316 837143	

3715	7.00 mm
4 901316 837150	

3716	8.00 mm
4 901316 837167	

3717	9.00 mm
4 901316 837174	

3718	10.00 mm
4 901316 837181	



Bamboo Knitting Needles Takumi®

Bamboo Circular Knitting Needles "Takumi®"



3016/100/3.0-9.0	
Bamboo Circular Knitting Needles "Takumi®" 100 cm	
Packing	1 pc./pack
3.0 - 6.5 mm	10 packs/box
7.0 - 9.0 mm	5 packs/box
Package Size	
3.0 - 6.5 mm	20 x 7.5 x 0.3 - 0.8 cm
7.0 - 9.0 mm	20 x 7.5 x 0.8 - 1.2 cm



3016/80/3.0-10.0	
Bamboo Circular Knitting Needles "Takumi®" 80 cm	
Packing	1 pc./pack
3.0 - 6.0 mm	10 packs/box
6.5 - 10.0 mm	5 packs/box
Package Size	
3.0 - 6.5 mm	20 x 7.5 x 0.3 - 0.8 cm
7.0 - 10.0 mm	20 x 7.5 x 0.8 - 1.2 cm



Bamboo Knitting Needles Takumi®

Bamboo Circular Knitting Needles "Takumi"®



3016/60/3.0-6.0	
Bamboo Circular Knitting Needles "Takumi"® 60 cm	
Packing	1 pc./pack 10 packs/box
Package Size	20 x 7.5 x 0.8 cm



3016/40/3.0-6.0	
Bamboo Circular Knitting Needles "Takumi"® 40 cm	
Packing	1 pc./pack 10 packs/box
Package Size	20 x 7.5 x 0.8 cm

*Only the sizes shown in the barcodes below are available for purchase.

3016/60/3.0	60 cm/3.0 mm
4 901316 849962	

3016/60/5.5	60 cm/5.5 mm
4 901316 850036	

3016/40/3.0	40 cm/3.0 mm
4 901316 848965	

3016/40/5.0	40 cm/5.0 mm
4 901316 849023	

3016/60/3.75	60 cm/3.75 mm
4 901316 849993	

3016/60/6.0	60 cm/6.0 mm
4 901316 850043	

3016/40/3.25	40 cm/3.25 mm
4 901316 848972	

3016/40/5.5	40 cm/5.5 mm
4 901316 849030	

3016/60/5.0	60 cm/5.0 mm
4 901316 850029	

3016/40/3.5	40 cm/3.5 mm
4 901316 848989	

3016/40/6.0	40 cm/6.0 mm
4 901316 849047	



Bamboo Knitting Needles Takumi®

Bamboo Knitting Needles "Takumi®" Double Pointed



3014/2.0-6.0	
Bamboo Knitting Needles "Takumi®" Double Pointed 16 cm	
Packing	5 pcs./pack 10 packs/box
Package Size	20.5 x 3.8 x 0.6 cm



3015/2.25-6.0	
Bamboo Knitting Needles "Takumi®" Double Pointed 20 cm	
Packing	5 pcs./pack 10 packs/box
Package Size	25.5 x 3.8 x 0.6 cm



Bamboo Knitting Needles Takumi®

Bamboo Knitting Needles "Takumi"® Single Pointed



3011/2.0-3.5	
Bamboo Knitting Needles "Takumi"® Single Pointed 23 cm	
Packing	2 pcs./pack 10 packs/box
Package Size	29 x 3.8 x 1.2 cm

*Only the sizes shown in the barcodes below are available for purchase.



3012/2.0-10.0	
Bamboo Knitting Needles "Takumi"® Single Pointed 33 cm/35 cm	
Packing	2 pcs./pack 10 packs/box/5 packs/box
Package Size	39 x 3.8 x 1.2 cm
Package Size	41 x 5 x 1.6 cm

3011/2.0	2.0 mm
4 901316 802202	

3011/2.5	2.5 mm
4 901316 802219	

3011/2.75	2.75 mm
4 901316 802301	

3011/3.5	3.5 mm
4 901316 802233	

3012/2.0	2.0 mm
4 901316 802516	

3012/2.25	2.25 mm
4 901316 802486	

3012/2.5	2.5 mm
4 901316 802523	

3012/2.75	2.75 mm
4 901316 802493	

3012/3.0	3.0 mm
4 901316 802530	

3012/3.5	3.5 mm
4 901316 802554	

3012/4.5	4.5 mm
4 901316 802585	

3012/6.5	6.5 mm
4 901316 802660	

3012/7.0	7.0 mm
4 901316 802622	

3012/8.0	8.0 mm
4 901316 802639	

3012/9.0	9.0 mm
4 901316 802646	

3012/10.0	10.0 mm
4 901316 802653	



Crochet Hooks

Soft Touch Crochet Hooks

The sophisticated design gives you the best crocheting experience

With these easy, soft-touch grips, your hands won't feel fatigue after long hours of crocheting.

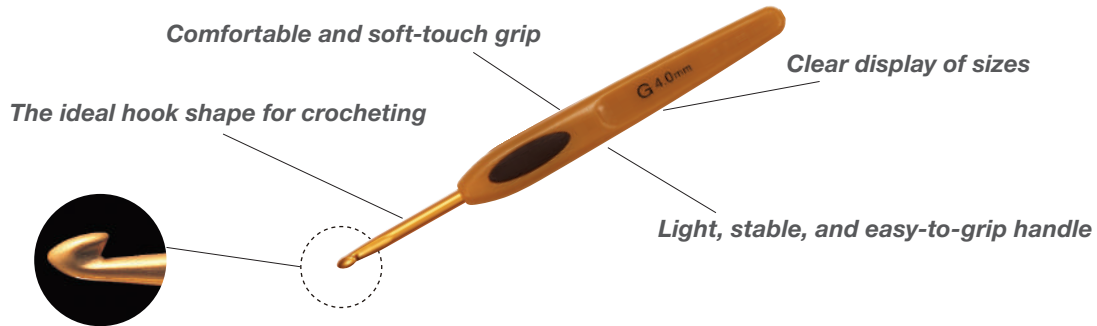

1001-1010 Soft Touch Crochet Hook	
1 pc./pack	3 packs/box
Package Size	19 x 4.1 x 1 cm
1001	
2.0 mm	0 51221 11451 9
1002	
2.25 mm	0 51221 11452 6
1030	
2.5 mm	0 51221 11453 3
1003	
2.75 mm	0 51221 11410 6
1031	
3.0 mm	0 51221 11454 0
1004	
3.25 mm	0 51221 11411 3
1005	
3.5 mm	0 51221 11412 0
1006	
3.75 mm	0 51221 11413 7
1007	
4.0 mm	0 51221 11414 4
1032	
4.5 mm	0 51221 11455 7
1008	
5.0 mm	0 51221 11415 1
1009	
5.5 mm	0 51221 11416 8
1010	
6.0 mm	0 51221 11417 5



1020-1027 Soft Touch Crochet Hook	
1 pc./pack	3 packs/box
Package Size	19 x 4.1 x 1 cm
1020	
1.75 mm	0 51221 11430 4
1021	
1.50 mm	0 51221 11431 1
1022	
1.25 mm	0 51221 11432 8
1023	
1.00 mm	0 51221 11433 5
1024	
0.90 mm	0 51221 11434 2
1025	
0.75 mm	0 51221 11435 9
1026	
0.60 mm	0 51221 11436 6
1027	
0.50 mm	0 51221 11437 3

Crochet Hooks

Amour Crochet Hooks

Amour crochet hooks are so comfortable to use that you won't want to stop.

With a soft, ergonomic handle and an ultra-smooth hook and shaft, crochet is always smooth and even.



Why Amour crochet hooks are the best choice:

Carefully designed hook

Easy to pull the yarn through the stitches and the stitches stay on the hook

Stitches don't slip off the hook making it easy to pick up stitches and pull the yarn through the stitches.

It is designed to make basic crocheting smooth and accurate.

<When picking up stitches>

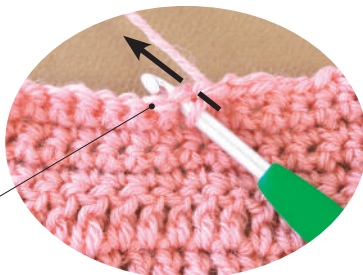

The small hook passes through the stitches easily

<When pulling the yarn through the stitches>

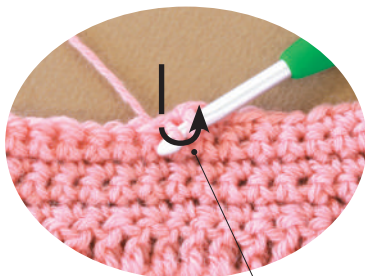

The deep hook holds the yarn securely

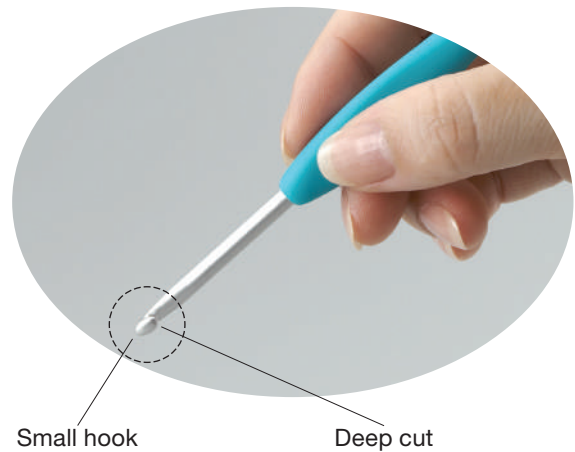

Hand-friendly grip

3D design achieves an easy grip

Grips with a 3D curve fit your fingertips comfortably. These perfectly fitting handles require no extra power, allowing you to knit tirelessly.

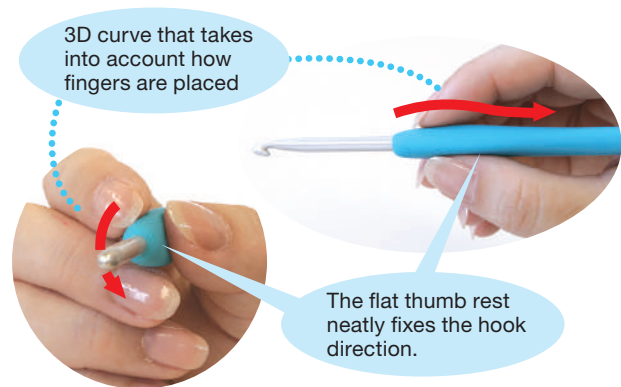

Soft and nonslip material

The entire grip is made of nonslip material to serve many different crocheting styles. It has a comfortable and soft touch.



Crochet Hooks



1050-1049 Amour Crochet Hook	
1 pc./pack	3 packs/box
Package Size	20 x 4.1 x 1.2 cm
1050	
2.0 mm	0 51221 71050 6
1051	
2.5 mm	0 51221 71051 3
1052	
3.0 mm	0 51221 71052 0
1043	
3.5 mm	0 51221 71043 8
1045	
4.0 mm	0 51221 71045 2
1046	
4.5 mm	0 51221 71046 9
1047	
5.0 mm	0 51221 71047 6
1048	
5.5 mm	0 51221 71048 3
1049	
6.0 mm	0 51221 71049 0

1053-1059 Amour Crochet Hook	
1053	
6.5 mm	0 51221 71053 7
1054	
7.0 mm	0 51221 71054 4
1055	
8.0 mm	0 51221 71055 1
1056	
9.0 mm	0 51221 71056 8
1057	
10.0 mm	0 51221 71057 5
1 pc./pack	3 packs/box
Package Size	22 x 4.5 x 1.6 cm
1058	
12.0 mm	0 51221 71058 2
1059	
15.0 mm	0 51221 71059 9
1 pc./pack	3 packs/box
Package Size	22 x 5.2 x 2.3 cm

3674 Amour Crochet Hook Set	
1 set/box	
Package Size	19 x 11 x 2.5 cm

Crochet Hooks

Why Amour crochet hooks are the best choice:

1. Easy-to-Use Crochet Hook

The hook is designed to prevent thread from slipping, and making picking up and pulling through of stitches easier.

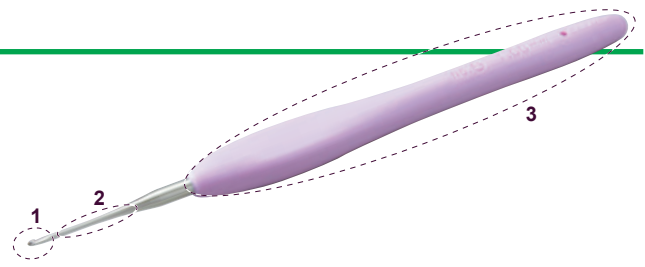

3. Soft, non-slip material is easy to grip reducing hand fatigue.

The three-dimensional curves on the grip fit your fingertips naturally. This naturally fitting design prevents you from gripping the needle unnecessarily tightly, stopping your hand from getting tired easily.

2. Beautiful even stitches because of long, uniform diameter shafts.

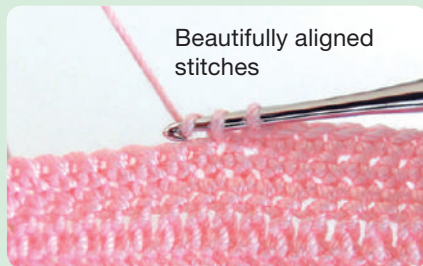

Beautifully aligned stitches

Uniform thickness of the wider part of the shaft will keep the stitches neatly aligned.

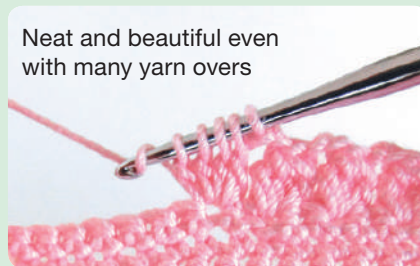

Neat and beautiful even with many yarn overs

Stitches with many yarn overs can be made beautifully as well.

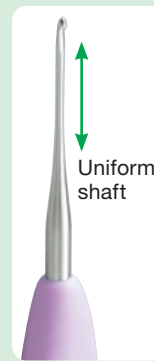

Uniform shaft

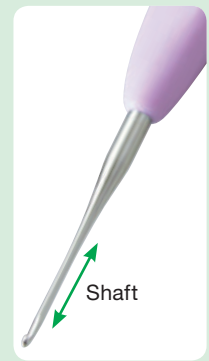

Shaft

1220-1226	
Amour Crochet Hook	
1 pc./pack	3 packs/box
Package Size	20 x 4.1 x 1.2 cm
1220	
1.75 mm	0 51221 71220 3
1221	
1.50 mm	0 51221 71221 0
1222	
1.25 mm	0 51221 71222 7
1223	
1.00 mm	0 51221 71223 4
1224	
0.90 mm	0 51221 71224 1
1225	
0.75 mm	0 51221 71225 8
1226	
0.60 mm	0 51221 71226 5
3675	
Amour Crochet Hook Set	
1 set/box	
Package Size	19 x 10 x 2.6 cm



1220



1221



1222



1223



1224



1225



1226



3675

Crochet Hooks



1305/G -1308/J	
Double Ended Tunisian Crochet Hook	
1 pc./pack	3 packs/box
Package Size	21 x 6.5 x 0.3 - 0.6 cm
1305/G	
4.0 mm	0 51221 11805 0
1306/H	
5.0 mm	0 51221 11806 7
1307/I	
5.5 mm	0 51221 11807 4
1308/J	
6.0 mm	0 51221 11808 1



Fun & Fast, Crocheting in the Round! Simply work in the round using the 2 hooks and alternating the 2 yarns.

• Example of circular knitting

Simply work in rounds in a spiral using the two hooks and alternating the two yarns. It's easy to use and you can knit non-stop.



Use two yarns and knit alternately. The crocheted fabric is circular.

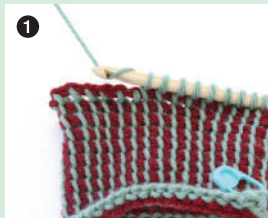

1 Pick up the stitch (the warp yarn of the preceding row or the back bump of chain stitch) with the left hook.



2 Use the right hook to stitch the other yarn and continue.

Enjoy different designs by combining yarns of different colours.

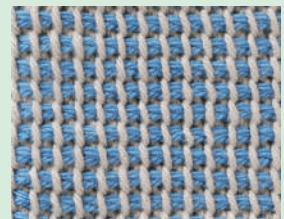

Plain Tunisian stitch

• Example of flat knitting



1 Pick up the stitch (the warp yarn of the preceding row or the back bump of chain stitch) with the left hook.



2 Pull up the yarn through the stitches from the left to the right.



3 Repeat 1 and 2.

Knitting Accessories

"To Finish"

Darning needles are essential for hand-knitting, including darning and grafting. Yarn-friendly darning needles that prevent yarns from splitting with their rounded tips.

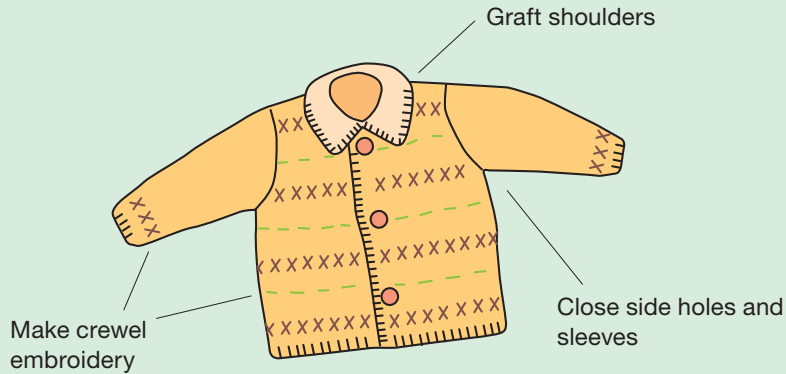

339
Darning Needle Set

3 needles/pack	3 packs/box
Package Size	16 x 5.5 x 2 cm

A darning needle set in a cute knitting needle shaped case.
 Needle sizes:
 No. 13, 17, 20



340
Jumbo Darning Needle Set

2 needles/pack	3 packs/box
Package Size	16 x 5.5 x 2 cm

A darning needle set in a cute knitting needle shaped case.
 Needle size: ø2.50 x 70.0 mm



3121
Darning Needle Set (Bent tip)

3 needles/pack	3 packs/box
Package Size	16 x 5.5 x 2 cm

A darning needle set in a cute knitting needle shaped case.
 Needle sizes:
 No. 15(2 pcs.), No. 17(1 pc.)



3168
Lace Darning Needle Set

3 pcs./pack	3 packs/box
Package Size	16 x 5.5 x 2 cm

Easy and convenient carrying case with a screw on cap stores needles neatly.
 Needle sizes:
 No. 20, 22 (Bent tip) / No. 24

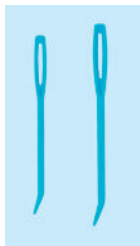

3113
Super Jumbo Tapestry Needle Set

2 needles/pack	3 packs/box
Package Size	15.5 x 5 x 0.5 cm

Large eye makes for easy threading of long-pile or extremely thick woolen yarn.
 The tip of the needle is slightly curved, making it easier to pick up stitches.

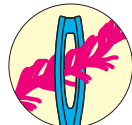

3160
Darning Needles with Latch Hook Eye

2 needles/pack	3 packs/box
Package Size	13 x 6.5 x 0.3 cm

Hook allows for easy threading of multi-ply and bulky yarns.

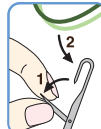



Knitting Accessories

Threader made specially for knitting yarn

Thread darning needles easily.

This plate-like solid threader with a large hole is very convenient when using threads that are difficult to thread, such as hard-twist lace thread and fancy yarn.

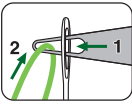
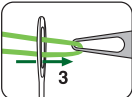
3142
Clover Yarn Threader



1 pc./pack	3 packs/box
Package Size	13 x 6.5 x 1 cm

Thread yarns easily!





3114
Antique Yarn Threader



1 pc./pack	3 packs/box
Package Size	13 x 6.5 x 0.5 cm

Antique designed threader for yarn and cotton lace.

Hold fabrics temporarily with marking pins before finishing with a mattress stitch or by grafting.



Large head keeps the pin in place

Long shaft makes it easy for you to pin thick fabrics

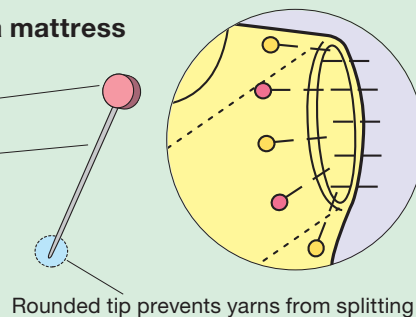
Pin and hold fabrics before closing side holes, grafting shoulder parts and connecting sleeves.
Use special marking pins for knitting which are long and have a rounded tip.



Rounded tip prevents yarns from splitting

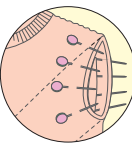



325
Marking Pins for Knitting



10 pins/pack	3 packs/box
Package Size	13 x 7.5 x 0.9 cm

Marking pins with a blunt tip will not split yarns.





3143
Bamboo Marking Pins



10 pins/pack	3 packs/box
Package Size	19 x 7 x 1 cm

Long marking pin for thick knitted fabrics.
Length: Approx. 7 cm
Pins made from the same materials as the Bamboo Knitting Needles "Takumi".



3163
Fork Blocking Pins



40 pins./pack	3 packs/box
Package Size	13 x 7.5 x 1.6 cm

U-Pin for secure pinning and easy removal.



Iron smoothly with fork-shared curved pins.

Finish knitted garments and sleeves by ironing

Place and pin the knitted fabric on an ironing board and steam. Leave some space (2-3 cm) between the iron and the fabric while steaming. Stitches and rounded edges will have a neat and beautiful finish.

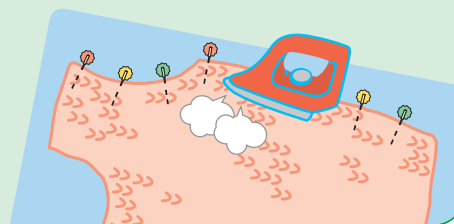

Knitting Accessories



3105
Yarn Cutter Pendant (Antique Gold)

0 51221 35663 6

3106
Yarn Cutter Pendant (Antique Silver)

0 51221 35664 3

1 pc./pack	3 packs/box
Package Size	13 x 6.5 x 0.8 cm

Yarn can be cut using any of the grooves. Rotary cutting blade is integrated with pendant, making it safe to use.

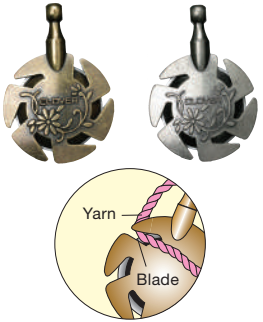

349
Yarn Guide (Large)

0 51221 70349 2

1 pc./pack	3 packs/box
Package Size	13 x 5.5 x 1.6 cm



Passing the yarn through the guide allows you to smoothly separate and knit two or more yarns for stranded knitting or color work. The cover can be opened and closed for easy insertion and removal of yarn. There is no need to worry about yarn slipping off during knitting.



Easy-to-fit open ring
 Inner diameter when open:
 approx. 45 (to 48) mm



328
Knitting Register

0 51221 35433 5

1 pc./pack	3 packs/box
Package Size	13 x 5 x 1.5 cm

A convenient register that can be inserted onto a straight knitting needle.

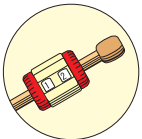

348
Yarn Guide

0 51221 35661 2

1 pc./pack	3 packs/box
Package Size	13 x 5.5 x 2 cm

A convenient ring type yarn guide.



3118
Mini Knitting Counter

0 51221 35523 3

1 pc./pack	3 packs/box
Package Size	16 x 7 x 1 cm

Track the number of knitted stitches and rows. Pendant style counter.



3164
Pattern Chart Marker Set

0 51221 73164 8

1 set/pack	3 packs/box
Package Size	36.5 x 11.6 x 0.25 cm

- Slip the Pattern Chart Marker onto the chart and hold in place with the attached magnet. Chart Marker moves easily to the next row as you work your pattern.
- You can use it as a book-mark for books or magazines.

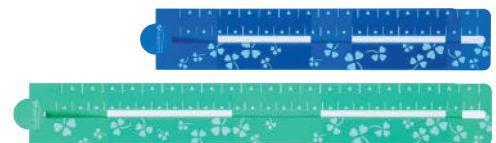

336
Knitting Counter

0 51221 35521 9

1 pc./pack	3 packs/box
Package Size	13 x 6.5 x 1.5 cm

Track the number of knitted stitches and rows with a push of a button.

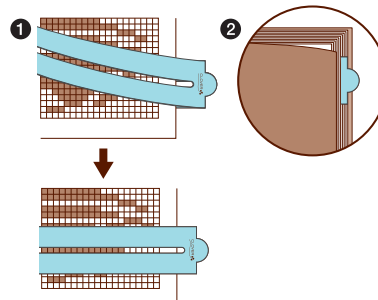

Knitting Accessories



3003 Knitting Accessory Set



1 set/pack	3 packs/box
Package Size	21 x 11 x 1.5 cm

Basic knitting tools in handy compact case.

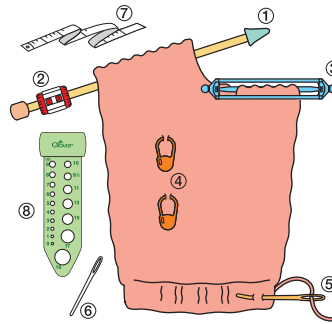

- Set contains:
- ① Point Protectors (Large): 2 pcs.
 - Point Protectors (Small): 2 pcs.
 - ② Knitting Register: 1 pc.
 - ③ Double-Ended Stitch Holders (Small): 2 pcs.
 - ④ Locking Stitch Makers: 20 pcs.
 - ⑤ Jumbo Tapestry Needle: 1 pc.
 - ⑥ Tapestry Needle (No. 17): 1 pc.
 - ⑦ Tape Measure (1.5 m): 1 pc.
 - ⑧ Knitting Needle Gauge: 1 pc.

Knit patterns

Aran sweaters with many cable and cross stitches, and Fair Isle sweaters with braids using two yarns are excellent in both design and heat-retention.

Try our convenient tools!

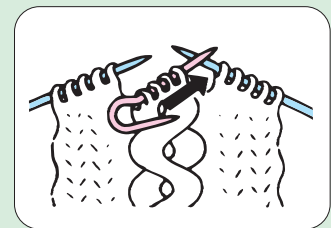
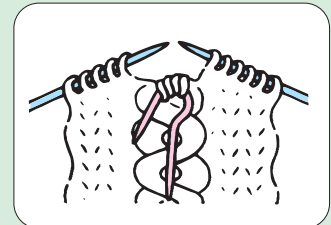

For Aran patterns and other cross stitches



341 Cable Stitch Holders (U-Shaped)



3 pcs./pack	3 packs/box
Package Size	16 x 5 x 1 cm

Designed to hold stitches at the U-shaped area. For regular size yarns.

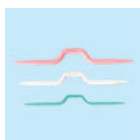
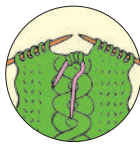

330 Cable Stitch Holders



3 pcs./pack	3 packs/box
Package Size	12.2 x 6.5 x 1 cm

Standard type for smooth knitting. Content: Large, Medium, Small 1 each.



3008 Jumbo Cable Stitch Holder Set "U"



2 pcs./pack	3 packs/box
Package Size	16.5 x 5.5 x 1.3 cm

Cable Stitch Holder for ultra thick yarns. U-shaped design prevents stitches from dropping. Small: 8 - 10 mm Large: 10 - 15 mm



Knit braid patterns

Convenient for braiding with multiple colours.



Keep yarns at the dent to prevent them from coming loose.

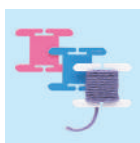

332 Knitting Bobbin Set



6 pcs./pack	3 packs/box
Package Size	13 x 6.5 x 1 cm

Convenient for knitting with multi-coloured yarns.

Knitting Accessories

To transfer stitches onto the Double-Ended Stitch Holder, remove either end cap of the elastic band from the double-point needle, slip stitches onto the Holder, then replace the end cap.

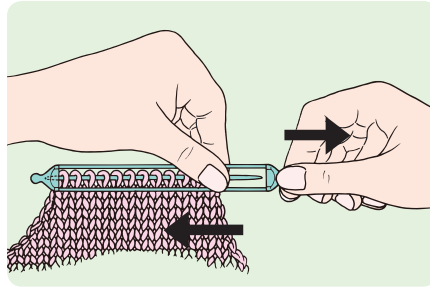
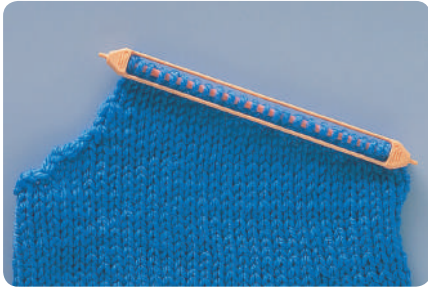

Position the cap so that it won't get in the way while grafting (for large and jumbo sized needles).

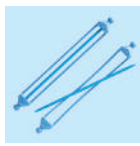

Length:
13.3 cm

351
Double-Ended Stitch Holder (Small)

2 pcs./pack	3 packs/box
Package Size	19.5 x 5 x 0.5 cm

Needle size: 2.75 - 4.5 mm

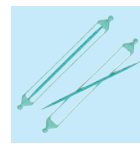

Length:
13.3 cm

3006
Double-Ended Stitch Holder (Medium)

2 pcs./pack	3 packs/box
Package Size	19.7 x 5 x 0.9 cm

Needle size: 3.75 - 8.0 mm



Length:
16.5 cm

352
Double-Ended Stitch Holder (Large)

2 pcs./pack	3 packs/box
Package Size	19.5 x 5 x 0.5 cm

Needle size: 3.75 - 8.0 mm

The extended length is suitable for works with many stitches.

Stitch holder with soft, pliable cord is a convenient way to store your circular work. Keeps the shape without compromising the stitches. Length of cord is adjustable depending on the number of stitches to be held.

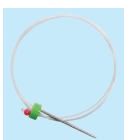

3161
Circular Stitch Holder (Short)

1 pc./pack	3 packs/box
Package Size	13 x 10 x 1.2 cm

For Circular Knitting Needles:
23 - 41 cm



3162
Circular Stitch Holder (Long)

1 pc./pack	3 packs/box
Package Size	13 x 10 x 1.2 cm

For Circular Knitting Needles:
61 - 91 cm

Knitting Accessories

Knit with markings

Are you counting stitches and rows over and over again? Count no more by simply placing these markers every 10-20 rows or where you have increased or decreased stitches. Then place stitch ring markers at the beginning of patterns for a smooth knitting experience.

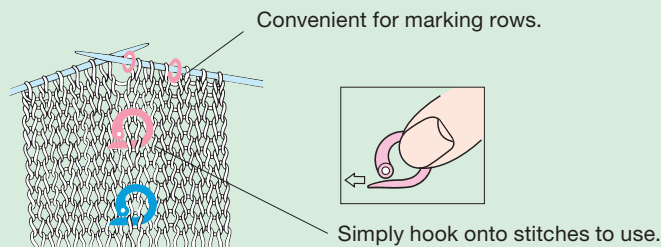

347	
Split Ring Markers	
	
24 pcs./pack	3 packs/box
Package Size	13 x 6.5 x 0.8 cm

Securely locks onto knitted stitches. One-touch action for placement and removal.

The round plastic rings in two sizes are slipped on the needles to mark the beginning and ending of pattern stitches, increasing, decreasing on the garment.





329

Stitch Ring Markers



10 small, 20 large rings/pack	3 packs/box
Package Size	13 x 6.5 x 0.8 cm

Small for needle size: 2.0 - 4.0 mm
Large for needle size: 4.0 - 6.5 mm





354

Jumbo Stitch Ring Markers



10 small, 10 large rings/pack	3 packs/box
Package Size	13 x 6.5 x 0.5 cm

A thin ring marker for uniform knitting.
Small for needle size: 8.0 - 10.0 mm
Large for needle size: 12.75 - 19.0 mm







3107

Soft Stitch Ring Markers



10 small, 20 large rings/pack	3 packs/box
Package Size	13 x 6.5 x 0.5 cm

Small for needle size: 2.0 - 3.75 mm
Large for needle size: 3.75 - 8.0 mm

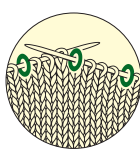
3108

Soft Jumbo Stitch Ring Markers



10 small, 20 large rings/pack	3 packs/box
Package Size	13 x 6.5 x 0.5 cm

Small for needle size: 8.0 - 10.0 mm
Large for needle size: 12.75 - 19.0 mm

The Stitch Markers Triangle have a specific triangle shape that allows the knitting needle tips to slip in easily when passing the markers from one needle to another.



3148

Stitch Markers Triangle (XS)



24 pcs./pack	3 packs/box
Package Size	13 x 6.5 x 0.3 cm

Needle size: 2.0 - 3.5 mm



3149

Stitch Markers Triangle (Small)



16 pcs./pack	3 packs/box
Package Size	13 x 6.5 x 0.5 cm

Needle size: 3.75 - 5.0 mm





3150

Stitch Markers Triangle (Medium)



16 pcs./pack	3 packs/box
Package Size	13 x 6.5 x 0.5 cm

Needle size: 5.5 - 6.5 mm

Knitting Accessories

Quick Locking Stitch Markers

Lock-type stitch marker.

It can also be used in the unlocked position. Its undulated design prevents stretching of knitted stitches.



The small size is perfect for fine stitching on socks and laces.



The medium size is ideal for a wide range of projects including accessories and clothes.



The large size is suitable for Cowichan and fancy yarns in which medium-sized markers might be buried.

3030	
Quick Locking Stitch Markers (Small)	
20 pcs./pack	3 packs/box
Package Size	13 x 6.5 x 0.4 cm

3031	
Quick Locking Stitch Markers (Medium)	
20 pcs./pack	3 packs/box
Package Size	13 x 6.5 x 0.5 cm

3032	
Quick Locking Stitch Markers (Large)	
12 pcs./pack	3 packs/box
Package Size	13 x 6.5 x 0.6 cm

3033	
Quick Locking Stitch Marker Set	
1 set/pack	3 packs/box
Package Size	16 x 10 x 2.3 cm



Lock-type stitch marker.

It can also be used in the unlocked position. Its undulated design prevents stretching of knitted stitches. Handy compact case included. Small: 10 pcs./Medium: 20 pcs./Large: 6 pcs.

3034	
Knitting Accessory Set for Beginners	
1 set/pack	3 packs/box
Package Size	16 x 10 x 2.3 cm



Basic accessories in handy compact case.

A convenient starter set with knitting accessories that you'll use frequently.

- Quick Locking Stitch Markers (10 pcs.)
- Soft Stitch Ring Markers (Small: 20 pcs. /Large: 20 pcs.)
For needle sizes Small: 2.0 mm – 3.75 mm
Large: 3.75 mm – 8.0 mm
- Point Protectors (2 pcs.)
For needle sizes: 3.75 mm – 6.5 mm



3165	
Locking Stitch Markers with Clip	
6 pcs./pack	3 packs/box
Package Size	16 x 8 x 0.6 cm

- You can attach notes to stitches!
- Perforated notepad included!

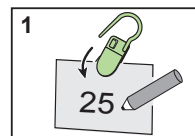

1. Write a note and clip it.

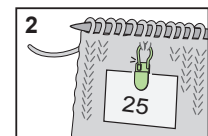

2. Attach to a stitch.

Lock-type stitch marker that stays in place for worry-free knitting



353	
Locking Stitch Markers	
20 pcs./pack	3 packs/box
Package Size	13 x 6.5 x 0.8 cm

Locks onto knitted stitches for worry-free knitting.



3109	
Jumbo Locking Stitch Markers	
12 pcs./pack	3 packs/box
Package Size	13 x 6.5 x 0.8 cm

Perfect for super bulky yarn.

Knitting Accessories



333/S

Point Protectors (Small)



4 pcs./pack 3 packs/box
 Package Size 13 x 6.5 x 1.2 cm

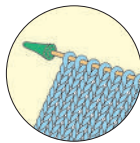

A knitting needle cap to prevent knitted stitches from falling off.
 Needle size: 2.0 - 4.5 mm



333/L

Point Protectors (Large)



4 pcs./pack 3 packs/box
 Package Size 13 x 6.5 x 1.5 cm

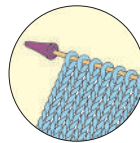

A knitting needle cap to prevent knitted stitches from falling off.
 Needle size: 3.75 - 6.5 mm



3140

Point Protectors and Stopper



6 pcs./pack 3 packs/box
 Package Size 13 x 6.5 x 1 cm

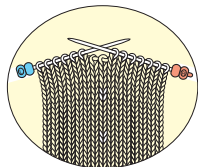

3 pairs of knitting needle caps to prevent stitches from falling off.
 Cap colours tell you which side of the fabric you are working on!
 Needle size: 2.0 - 6.5 mm



3141

Point Protectors Petit



4 pcs./pack 3 packs/box
 Package Size 13 x 6.5 x 1 cm

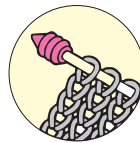

2 pairs of caps that prevents knitted stitches from slipping off. Light and easy to use!
 Needle size: 2.0 - 6.5 mm



3004

Point Protector for Circular Knitting Needles (Small)



4 pcs./pack 3 packs/box
 Package Size 13 x 6.5 x 1 cm

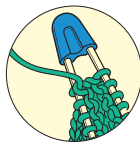

Compactly stores without spreading needles.
 Needle size: 2.0 - 5.0 mm



3005

Point Protector for Circular Knitting Needles (Large)



4 pcs./pack 3 packs/box
 Package Size 13 x 6.5 x 1 cm

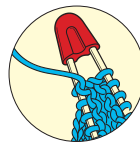

Compactly stores without spreading needles.
 Needle size: 5.0 - 10.0 mm

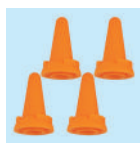

3110

Jumbo Point Protectors (Small)



4 pcs./pack 3 packs/box
 Package Size 13 x 7 x 2.5 cm

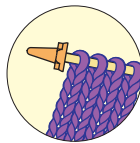

A knitting needle cap to prevent knitted stitches from falling off.
 Needle size: 8.0 - 10.0 mm



3112

Jumbo Point Protectors (Large)



2 pcs./pack 3 packs/box
 Package Size 13 x 7 x 2.8 cm

Prevents stitches from slipping off knitting needle.
 For needle sizes: 12.75 mm - 15.0 mm

3120

Knitting Needle Tube Case <Designer Case> Purple



1 pc./pack 3 packs/box
 Package Size 44 x 7.5 x 3.5 cm

Accommodate knitting needles up to 35 cm long. Knitting accessories can be stored in the bottom case.

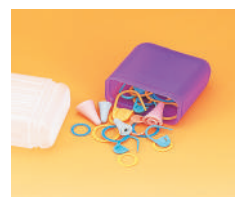

Size: 41 x 6 x 3.5 cm

Knitting Accessories

Convenient for storing needles!

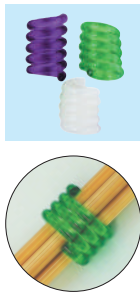

3122
Coil Knitting Needle Holders (Large)

3 pcs./pack	3 packs/box
Package Size	13 x 6.5 x 1.2 cm

Non-slip holder winds around knitting needles.
Needle size:
Single Pointed: 6.0 - 10.0 mm
Double Pointed: 4.5 - 6.5 mm

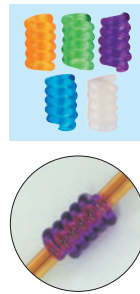

3123
Coil Knitting Needle Holders (Small)

5 pcs./pack	3 packs/box
Package Size	13 x 6.5 x 1 cm

Non-slip holder winds around knitting needles.
Needle size:
Single Pointed: 2.75 - 5.5 mm
Double Pointed: 2.0 - 4.0 mm

Convenient coil-style knitting needle holder

Perfect for storing and carrying around

Neatly bundle knitting needles and circular needles that are hard to organise. Convenient for storing and carrying around.

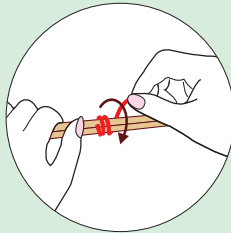

Bundle easy and tight

Simply wind the coil around needles to hold them together neatly without slipping.

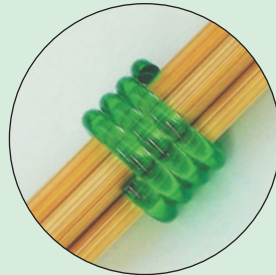

Use different colours to distinguish between needles

Use a different colour depending on the needle size and length.

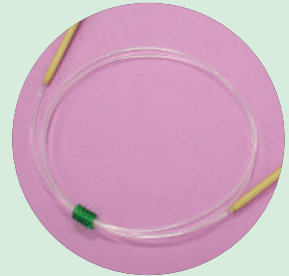

3200
Swatch Ruler and Needle Gauge

1 pc./pack	3 packs/box
Package Size	22 x 16.2 x 0.2 cm

Measure your crochet hook or knitting needle size in US, metric and Japanese standard sizes. The Swatch Ruler allows you to isolate a section of your work to easily count both stitches and rows.

A multi-purpose tool for knitting and crochet.

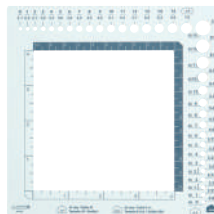

Knitting needle gauge



Crochet hook gauge



Swatch ruler



3147
Knitting Needle Gauge

1 pc./pack	3 packs/box
Package Size	13 x 10 x 0.2 cm

Measures 20 needles sizes.
Needle size: 2.0 - 15.0 mm

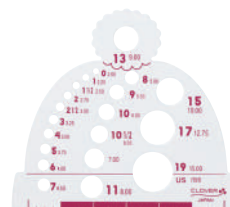

Knitting Accessories

For repairing and correcting stitches

“Repair Hook” for fixing incorrect knitted stitches

- Made with “Takumi” quality bamboo

Quickly repair with a smoothly finished surface.

Sharp needle tips that easily undo stitches

3.5 mm

4.5 mm

Bamboo will prevent the hook from slipping down, even if you accidentally let go of it.

Sharp hook tips that easily pass through stitches

This set contains hooks of two different sizes to serve a variety of situations.

- Compact and convenient

- For cast-on stitches and pick-up stitches

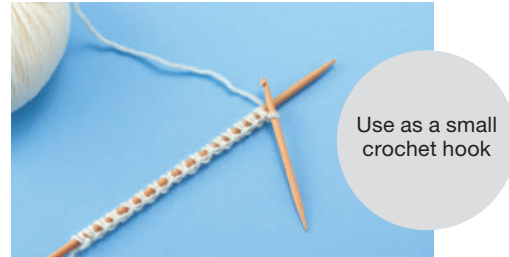

- For detangling yarns such as mohair



3009
Bamboo Knitting Repair Hooks

2 pcs./pack	3 packs/box
Package Size	16 x 8 x 1 cm



4.5 mm (3/16 in.) x 10 cm



3.5 mm (1/8 in.) x 10 cm



Handy hooks for repairing incorrect stitches. Use the sharp point end to unravel stitches as needed and the hook end to pick up new stitches.

Black Gold Needles



Needle Surface : Smooth and rust-resistant

Polished along the needle shaft

Significantly less friction when compared to standard needles. (Clover comparison).

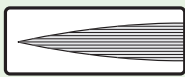

The surface is polished lengthwise.

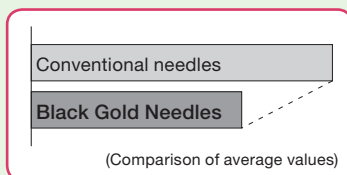

Special black plating

The special black plating provides outstanding rust resistance compared to conventional nickel plating. (Clover comparison).

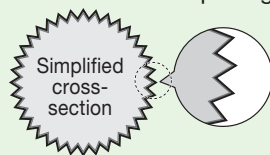

Needle Tip : Sharp and strong needle tip

Clover's unique polishing process. To strengthen the tip, the first 0.5 mm are polished to a cone shape.



Needle Eye :

Shaped for easy threading

Clover's original oval shape adds strength to the eye while lengthening it for easy threading.

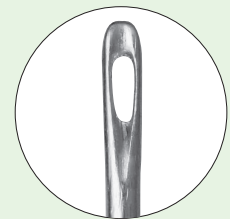

Gentle on threads

The needle eye is plated with pure gold. The characteristic softness of gold prevents the thread from fraying and breaking.

Designed to pass smoothly through fabric

Grooved for smooth stitching through fabric.

Needle Shaft : Bend and break-resistant

The needle shaft uses high-quality steel. Our quenching and tempering processes maximise the strength and elasticity characteristics for the optimum balance.

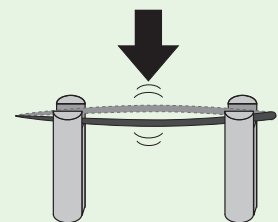



Black Gold Needles

Quilting Between



4960	Black Gold Needles Quilting Between (No. 9)	
4961	Black Gold Needles Quilting Between (No. 10)	
4962	Black Gold Needles Quilting Between (No. 12)	
4963	Black Gold Needles Quilting Between (No. 9/No. 10/No. 12)	

6 needles/pack	3 packs/box
Package Size	15 x 5 x 0.3 cm

No. 9	0.53 x 27.0 mm
No. 10	0.46 x 25.4 mm
No. 12	0.53 x 24.4 mm

Quilting



4980	Black Gold Needles Quilting (No. 9)	
4981	Black Gold Needles Quilting (No. 10)	
4982	Black Gold Needles Quilting (No. 12)	
4983	Black Gold Needles Quilting (No. 9/No. 10/No. 12)	

6 needles/pack	3 packs/box
Package Size	15 x 5 x 0.3 cm

No. 9	0.56 x 27.3 mm
No. 10	0.56 x 25.8 mm
No. 12	0.51 x 22.7 mm

Appliqué/Sharps



4970	Black Gold Needles Appliqué/Sharps (No. 9)	
4971	Black Gold Needles Appliqué/Sharps (No. 10)	
4972	Black Gold Needles Appliqué/Sharps (No. 12)	
4973	Black Gold Needles Appliqué/Sharps (No. 9/No. 10/No. 12)	

6 needles/pack	3 packs/box
Package Size	15 x 5 x 0.3 cm

No. 9	0.53 x 34.9 mm
No. 10	0.46 x 33.3 mm
No. 12	0.46 x 28.8 mm

Sewing, Quilting & Embroidery Needles

Superior Quality Clover Needles

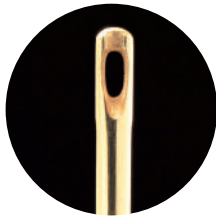

- The needles will glide through fabric smoothly.
- The needle has Gold-Eye plating with a unique elliptical design for easy threading.
- The hardness of steel was obtained through high temperature treatment and tempering, making our needle hard to break or bend.
- Nickel plated for smooth sewing.
- Sharp needle point.



468/09
Quilting Needles
(No. 9)

0 51221 40105 3

468/10
Quilting Needles
(No. 10)

0 51221 40103 9

468/12
Quilting Needles
(No. 12)

0 51221 40101 5

15 needles/pack	12 packs/box
Package Size	13 x 5 x 0.5 cm

No. 9	0.56 x 27.3 mm
No. 10	0.56 x 25.8 mm
No. 12	0.51 x 22.7 mm



496/08
Gold Eye Quilting Needles
Between (No. 8)

0 51221 40332 3

496/09
Gold Eye Quilting Needles
Between (No. 9)

0 51221 40307 1

496/10
Gold Eye Quilting Needles
Between (No. 10)

0 51221 40308 8

496/12
Gold Eye Quilting Needles
Between (No. 12)

0 51221 40309 5

15 needles/pack	12 packs/box
Package Size	13 x 5 x 0.5 cm

No. 8	0.61 x 28.6 mm
No. 9	0.53 x 27.0 mm
No. 10	0.46 x 25.4 mm
No. 12	0.53 x 24.4 mm



497/09
Gold Eye Appliqué Needles
(No. 9)

0 51221 40321 7

497/10
Gold Eye Appliqué Needles
(No. 10)

0 51221 40322 4

497/12
Gold Eye Appliqué Needles
(No. 12)

0 51221 40323 1

15 needles/pack	12 packs/box
Package Size	13 x 5 x 0.5 cm

No. 9	0.53 x 34.9 mm
No. 10	0.46 x 33.3 mm
No. 12	0.46 x 28.8 mm



2006
Self-Threading Needles
(Assorted)

0 51221 40707 9

5 needles/pack	12 packs/box
Package Size	10.4 x 5 x 0.5 cm

The needles have a built-in threader. Place thread in U-shaped groove and pull down to thread.

0.89 x 42.5 mm
0.76 x 38.0 mm
0.71 x 36.5 mm
0.64 x 42.5 mm
0.64 x 34.9 mm

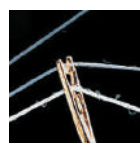

Sewing, Quilting & Embroidery Needles



234/18
Gold Eye Chenille Needles
(No. 18)

0 51221 40311 8

234/20
Gold Eye Chenille Needles
(No. 20)

0 51221 40312 5

234/22
Gold Eye Chenille Needles
(No. 22)

0 51221 40313 2

234/24
Gold Eye Chenille Needles
(No. 24)

0 51221 40314 9

6 needles/pack	12 packs/box
Package Size	13 x 5 x 0.5 cm



235
Gold Eye Embroidery Needles
(No. 3 - 9)

0 51221 40315 6

16 needles/pack	12 packs/box
Package Size	13 x 5 x 0.5 cm



238
Gold Eye Tapestry Needles
(No. 18, 20, 22)

0 51221 40318 7

238/24
Gold Eye Tapestry Needles
(No. 24)

0 51221 40320 0

6 needles/pack	12 packs/box
Package Size	13 x 5 x 0.5 cm



2012
Huck Embroidery Needles

0 51221 40712 3

3 needles/pack	12 packs/box
Package Size	14.5 x 5 x 0.5 cm

The tip is rounded and curved so cloth can be easily scooped.



Sewing, Quilting & Embroidery Needles

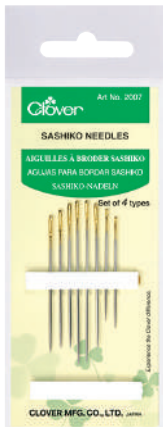

2007 Sashiko Needles



8 needles/pack	12 packs/box
Package Size	10.4 x 4.5 x 0.5 cm



2009 Sashiko Needles (Long Type)



3 needles/pack	12 packs/box
Package Size	14.5 x 5 x 0.5 cm

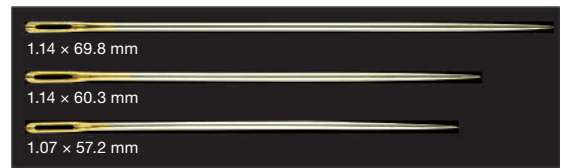
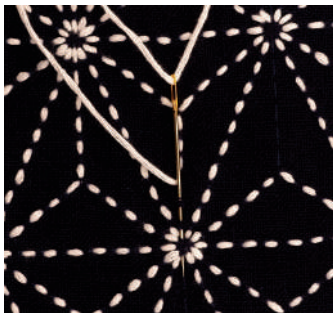
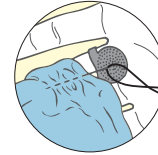

237/10 Gold Eye Sharps Needles (No. 10)



20 needles/pack	12 packs/box
Package Size	13 x 5 x 0.5 cm

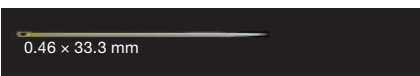

236 Gold Eye Milliners Needles (No. 3, 5, 7, 9)



16 needles/pack	12 packs/box
Package Size	13 x 5 x 0.5 cm

Long needles with round eyes used for: Bonnet and hat making, pleating, ribbon embroidery and embellishing decorations.



233 Beading Needles (No. 10, 13)



4 needles/pack	12 packs/box
Package Size	13 x 5 x 0.5 cm

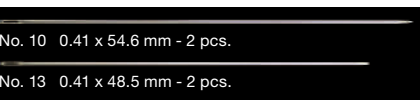



Sewing, Quilting & Embroidery Needles

Easily repair snags in knitted and woven garments!



2512	
Snag Repair Needles	
0 51221 72512 8	
2 needles/pack	3 packs/box
Package Size	17 x 5 x 0.2 cm

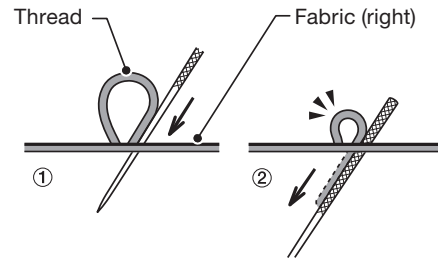
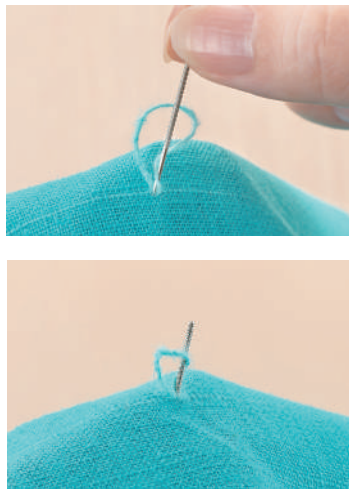
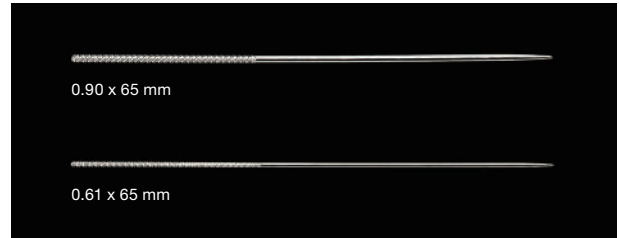

- ① Insert needle in the snag's center.
- ② Pull needle through fabric, capturing entangled thread as you pull.

Pins

Wonder Pins



3210	
Wonder Pins (20pcs.)	
0 51221 73210 2	
20 pcs./pack	3 packs/box
Package Size	12 x 7.3 x 2.1 cm



Quick and easy quilt basting

The curved pin makes scooping and holding the fabric easy.

- Scoop 3 layers (top, batting and backing) of fabric keeping them spread out flat.

- Tip manufactured to ensure ease of pinning through fabric.

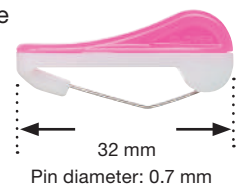

Simply push the pin down. Easily open and close with one hand.

Speedy basting and reduced hand fatigue.

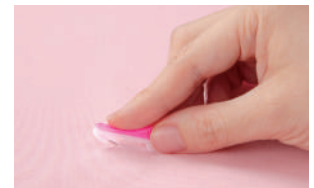

Can be used in places where Clips cannot reach.

With closed pins, no worry about pricking yourself.

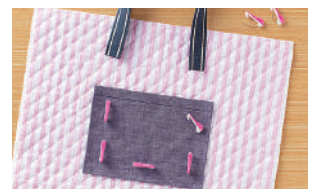

How to use

1. Scoop up the fabric.
2. Push down the closure, keeping the pin tip upwards and the base of pin touching fabric surface.
3. The pin is secured when it enters the closure.

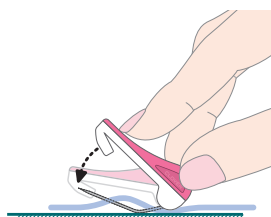

Pins

Heat resistant glass head suited for ironing.

- 0.5mm thin marking pins.
- Holes are hardly visible and the pins will smoothly pass through fabrics.
- The pins have a fine pointed tip and is made of tough steel.

Easy-grasp large head and sharp finish!

The heart-shaped head featured on these pins make them easy to grab, the sharp finish make them easy to use. Their flat head is convenient for machine stitching and ironing.

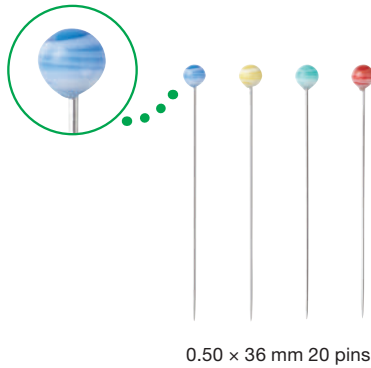

0.50 x 36 mm 20 pins



9604	
Heart-Shaped Pins	
1 set/pack	3 packs/box
Package Size	11.5 x 6 x 0.4 cm

0.55 x 50 mm 20 pins



2511	
Marbled Glass Head Pins	
1 set/pack	3 packs/box
Package Size	11.5 x 6.3 x 0.4 cm



Flower Head Pins

Flower Head Pins can hold multiple layers of fabric.
The flat head is convenient for machine stitching.
Head is not heat-resistant. Do not apply iron directly. 3 different sizes.



2505	
Flower Head Pins	
0.55 mm	

2505



0.55 x 50 mm

The pins will hold regular fabric of cotton, linen and wool.

2510	
Flower Head Pins	
0.45 mm	

2510



0.45 x 50 mm

Superfine-pointed, 0.45mm marking pins will pass through fabric smoothly.
The pins will gently hold thin fabrics such as silk, silk crepe, satin and lining fabric.



2506	
Flower Head Pins Boxed	

2506



0.70 x 54 mm

100 pins/case	3 cases/box
Package Size	12.2 x 7.4 x 2 cm



Iron-proof glass



232
Patchwork Pins

100 pins/case	3 cases/box
Package Size	11.5 x 6 x 1.6 cm

The needle head is small and the tip is sharp. The pins have very sharp points.

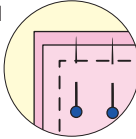

Iron-proof glass



2507
Patchwork Pins (Fine)

100 pins/case	3 cases/box
Package Size	11.5 x 6 x 1.6 cm

Extra-fine pins, which smoothly pass through fabric. Useful for precise pinning in delicate piecework and appliqué.



Iron-proof glass



2508
Quilting Pins

100 pins/case	3 cases/box
Package Size	11.5 x 6 x 1.6 cm

Perfectly suited for quilting, as the pins feature a sharp tip and strong shaft.



Iron-proof glass



2509
Quilting Pins (Fine)

100 pins/case	3 cases/box
Package Size	11.5 x 6 x 1.6 cm

Pins smoothly pass through fabric, as the pin tips are thin and sharp.



Iron-proof glass



231
Appliqué Pins

150 pins/case	3 cases/box
Package Size	11.5 x 6 x 1.6 cm

Short pins (2 cm) are perfect for small appliqué work. It will not stick out since it is short.

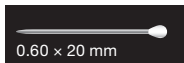

Fork Pins



240
Fork Pins

35 pins/case	3 cases/box
Package Size	13 x 7.4 x 1.6 cm

2401
Fork Pins (70 pcs.)

70 pins/case	3 cases/box
Package Size	13 x 7.4 x 1.6 cm

The double pins can pierce and firmly hold slippery lining materials in place. The tip is bent for easy pinning.

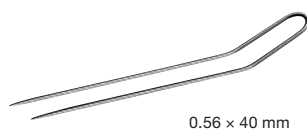

Thimbles

Natural Fit Leather Thimbles

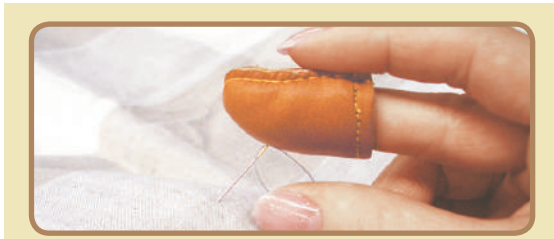

Feature 1 *Seamless from top to side!*



This thimble is made with three-dimensional stitching without seams or stitches in the area where the needle touches, allowing the needle to be pushed from the most convenient spot. Its side is made of full double leather to provide safety.

Feature 2 *Fits the curve of your finger tip naturally!*



The unique shape creates a smooth curve from the edge of the fingertip to the middle of the finger. It fits the curve of your finger tip naturally.



6028
Natural Fit Leather Thimble (Small)

6030
Natural Fit Leather Thimble (Large)

6029
Natural Fit Leather Thimble (Medium)

1 pc./pack	3 packs/box
Package Size	15 x 6.5 x 2 cm



6014
Coin Thimble (Medium)

1 pc./pack	3 packs/box
Package Size	12.7 x 5 x 1.5 cm

Soft leather thimble with coin metal dimpled disk.

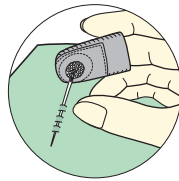

616
Double Sided Thimble

1 pc./pack	3 packs/box
Package Size	12.7 x 5 x 1.5 cm

Made of soft leather. This thimble has double sided metal "dimpled" tip.



610
Adjustable Ring Thimble

1 pc./pack	3 packs/box
Package Size	10.5 x 6.5 x 1.4 cm

The metal thimble can be used for thick needles and can be adjusted to any finger size.



611
Adjustable Ring Thimble with Plate

1 pc./pack	3 packs/box
Package Size	10.5 x 6.5 x 1.4 cm

Designed for long-running stitches using a long needle or Sashiko. Adjustable to fit any finger.

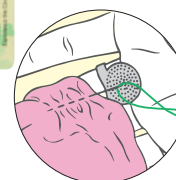

clover Thimbles

6017
Open Sided Thimble (Small)



6018
Open Sided Thimble (Medium)



1 pc./pack	3 packs/box
Package Size	14.5 x 6.5 x 2 cm



6017



6018



Adjustable Open Sided Thimble that fits your finger comfortably. Designed with an open top to keep your finger from perspiring. Dimpled for easy use on needles. Suited for people with long fingernails.

Protect and Grip Thimbles



6025
Protect and Grip Thimble (Small)



6027
Protect and Grip Thimble (Large)



6026
Protect and Grip Thimble (Medium)

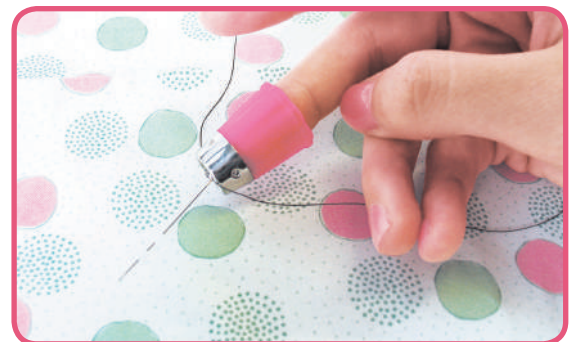
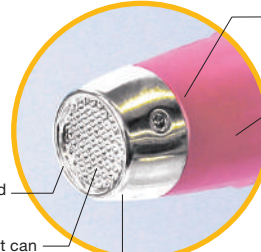

1 pc./pack	3 packs/box
Package Size	15 x 6.5 x 2 cm

Finger friendly soft rubber
Fits gently on your finger without a tight feeling

Excellent breathability with its unique corrugated shape

Dimpled and Ridged

Metal top that can be pushed firmly without danger

50 to 80% lighter than a metal thimble (compared to our conventional product)

Because only a small area touches your finger, this thimble does not make your finger sweaty.



Flexible Rubber Thimbles

Tight grip to easily pull out the needle.



6031
Flexible Rubber Thimbles (Medium)



6032
Flexible Rubber Thimbles (Large)



2 pcs./pack	3 packs/box
Package Size	15 x 6.5 x 2 cm

2 pcs./pack	3 packs/box
Package Size	15 x 6.5 x 2 cm

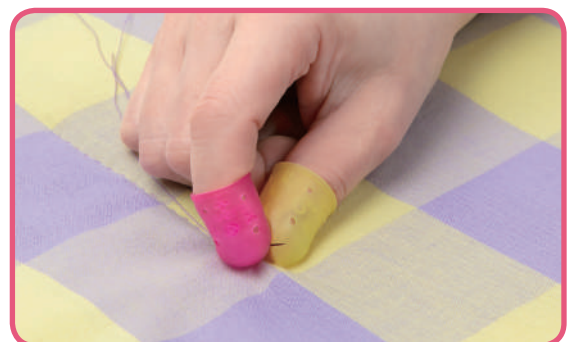

- Index finger thimble for easily pulling needle through fabric.
- Flexible for a perfect fit.
- Cooling vents for breathability.

Sewing Notions

480/W	
Tracing Wheel (Serrated Edges)	
0 51221 50036 7	
1 pc./pack	3 packs/box
Package Size	19 x 4.5 x 1.4 cm

The tracing wheel is used for marking directly onto fabrics. Suitable for marking on thin fabrics.

Trace and mark the holes by rolling the wheel forward along the paper pattern.

481/W	
Tracing Wheel (Blunt Edges)	
0 51221 50039 8	
1 pc./pack	3 packs/box
Package Size	19 x 4.5 x 1.4 cm

This wheel is used when transferring the pattern to fabrics using Tracing Paper “Clover Chacopy”.

The blunt edges will mark the line without tearing the pattern or Chacopy carbon paper.

487/W	
Double Tracing Wheel	
0 51221 50042 8	
1 pc./pack	3 packs/box
Package Size	19 x 5.5 x 1.4 cm

The Double Tracing Wheel can draw two lines at the same time and the space between each wheel can be changed in units of 5mm.

Seam line and cutting line can be marked at the same time.

The space between the two wheels can be adjusted in units of 5mm between 10-30mm.

484/W	
Buttonhole Cutter	
0 51221 50203 3	
1 pc./pack	3 packs/box
Package Size	19 x 4.5 x 1.4 cm

This cutter makes the job of opening buttonholes or small cuts on fabrics easy.

After stitching a buttonhole, use this cutter to open it by placing and pressing the blade on the beads of the buttonhole vertically.

This cutter is also useful for making small cuts and cutting through curves. (12mm wide)

Sewing Notions

The Straight Tailor's Awl and the Tapered Tailor's Awl are convenient for detailed work.

These awls are used for detailed work such as shaping the edges, feeding the cloth into the sewing machine and untying threads. With a sharp edge like an artillery shell, the awl is suitable for marking and opening holes especially for thick fabrics and leather.



485/W
Straight Tailor's Awl

1 pc./pack	3 packs/box
Package Size	19 x 4.5 x 1.4 cm

Designed for piercing small holes or craft works for doll making.

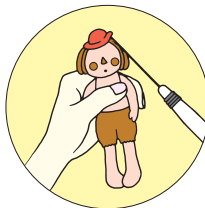

486/W
Tapered Tailor's Awl

1 pc./pack	3 packs/box
Package Size	19 x 4.5 x 1.4 cm

Very useful in punching holes in leather and fabrics, pulling out corners and widening out spaces.



4880
Curved Tailor's Awl

1 pc./pack	3 packs/box
Package Size	19 x 4.5 x 1.4 cm

With its curved tip, this awl is perfect for such tasks as producing curves, feeding cloth, or undoing seams. In addition, the tip has a smooth finish, which makes injury to the cloth or your fingers difficult.



876
Ball Point Awl

1 pc./pack	3 packs/box
Package Size	19 x 4.5 x 1.4 cm

The Ball Point Awl is used for making a hole by carefully stretching the fabric without thread breakage.



Used to cut threads by placing the longer tip under the thread and pushing forward.

The seam ripper comes with a small ball to protect it from damaging the fabric.



482/W
Seam Ripper

1 pc./pack	3 packs/box
Package Size	19 x 4.5 x 1.4 cm

Used to cut seams, basting threads or threads under buttons.

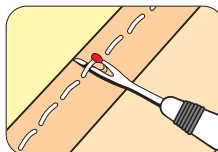

463
Seam Ripper

1 pc./pack	3 packs/box
Package Size	18.5 x 7.5 x 0.8 cm

Perfect for ripping out seams, cutting threads and buttonholes.

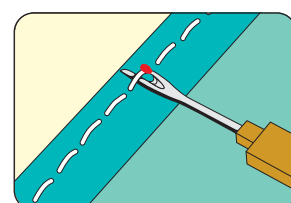

Marking Tools

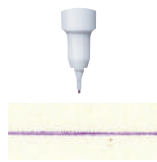

<Extra Fine>
Markings naturally disappear in 2 - 7 days.

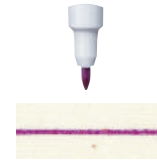

<Thick>
Markings naturally disappear in 4 - 14 days.

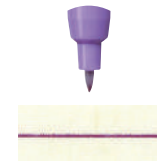

<Fine>
Markings naturally disappear in 4 - 14 days.

5030
Air Erasable Marker (Purple Extra Fine)

0 51221 75030 4

5031
Air Erasable Marker (Purple Thick)

0 51221 75031 1

5032
Air Erasable Marker with Eraser (Purple Fine)

0 51221 75032 8

1 pc./pack	3 packs/box
Package Size	21 x 4.3 x 1.2 cm



Fine

Thick

515
Water Erasable Marker (Fine)

0 51221 52301 4

1 pc./pack	3 packs/box
Package Size	19 x 4.3 x 1.2 cm

516
Water Erasable Marker (Thick)

0 51221 52302 1

1 pc./pack	3 packs/box
Package Size	19 x 4.3 x 1.2 cm

Markings can be quickly removed with water.



5013
Chacopen Blue with Eraser (Water Erasable)

0 51221 52319 9

1 pc./pack	3 packs/box
Package Size	19 x 4 x 1.2 cm

Water Erasable.
Comes with a convenient "ERASER PEN" for immediate erasure of unwanted marks.



518
Eraser Pen

0 51221 52304 5

1 pc./pack	3 packs/box
Package Size	19 x 4 x 1.2 cm

Used to remove markings made by Water Erasable Markers.

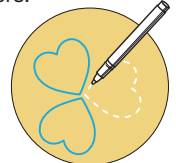

White Marking Pen



517
White Marking Pen (Fine)

0 51221 52303 8

1 pc./pack	3 packs/box
Package Size	21 x 4.3 x 1.2 cm

A white marker perfect for marking black and dark-coloured fabrics. Markings disappear when washed or ironed.



The white ink stands out on black and dark-coloured fabric.

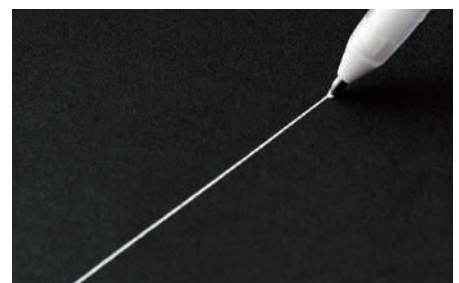

Marking Tools



5003
Water Soluble Pencil
(Package of 3)

0 51221 52310 6

3 pcs./pack	3 packs/box
Package Size	26 x 4 x 1.1 cm

5000
Water Soluble Pencil
(White)

0 51221 52307 6

5001
Water Soluble Pencil
(Blue)

0 51221 52308 3

5002
Water Soluble Pencil
(Pink)

0 51221 52309 0

1 pc./pack	3 packs/box
Package Size	26 x 4 x 1.1 cm

The Water Soluble Pencils can be easily wiped off with water.
Best suited for precise marking on fabric.



418
Chacopel Fine

0 51221 51456 2

1 set/pack	3 packs/box
Package Size	26 x 4.5 x 1 cm

Fine lines can be clearly marked.

Contents

- White: 1 pc.
- Yellow: 1 pc.
- Pink/Blue: 1 pc.
- Sharpener: 1 pc.

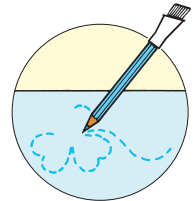

5004
Iron-On Transfer Pencil
(Red)

0 51221 52311 3

5005
Iron-On Transfer Pencil
(Blue)

0 51221 52312 0

1 pc./pack	3 packs/box
Package Size	26 x 4 x 1.1 cm

Draw designs with the Iron-On Transfer Pencil, and transfer it onto the fabric with an iron.
The traced design can be transferred to fabrics, papers and woodblocks.



For transferring the appliqué and doll designs.



Easy transfer with an iron.
The traced design can be used for 2-3 times.

How to use:

- (1) Place tracing paper on the design that you wish to transfer.
- (2) Trace the design with the Iron-On Transfer Pencil.
- (3) Place the traced design on the fabric and iron.
The traced design will appear on the fabric.

Marking Tools

A powder chalk which allows you to mark fabric as if you are drawing with a pen

A powder-based chalk for drawing thin, beautiful lines. With its pen-like use, you can make marks as if you are drawing freehand.

Features of Chaco Liner Pen Style

Length, thickness and angle that are easy to hold

The length and thickness have been designed to achieve the pen-like ease-of-use. Also, the chalk can be easily turned around to draw both straight and curved lines freely as it supports many different angles.

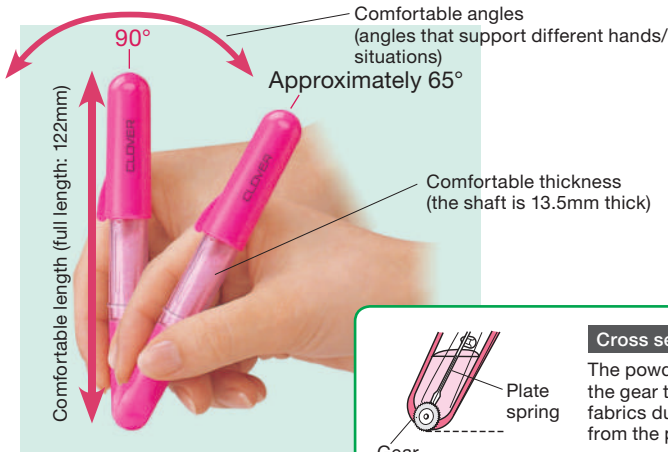

Marks can be easily made along the ruler

You can draw beautiful lines along the ruler with the pointed tip.

The amount of remaining powder is visible

You can see how much powder you have left through the transparent case.



Save time on refilling by exchanging the cartridge

Powder can be refilled easily by simply exchanging the cartridge. When refilling, the powder will hardly spill over or dirty your hand.

Smooth touch

The shape of the sharp gear tooth, inner parts and powder components were carefully reviewed to achieve a smooth touch.



4710
Chaco Liner Pen Style (Blue)

4711
Chaco Liner Pen Style (Pink)

4712
Chaco Liner Pen Style (White)

4713
Chaco Liner Pen Style (Yellow)

4714
Chaco Liner Pen Style (Silver)



NET: 2.5 g approx.



1 pc./pack 3 packs/box
Package Size 19 x 6.5 x 1.5 cm

Wheel tip powder chalk. Permits accurate markings for both straight lines and freehand curves.

Refills for Chaco Liner Pen Styles.



4720
Refill Cartridge for Chaco Liner Pen Style (Blue)

4721
Refill Cartridge for Chaco Liner Pen Style (Pink)

4722
Refill Cartridge for Chaco Liner Pen Style (White)

4723
Refill Cartridge for Chaco Liner Pen Style (Yellow)

4724
Refill Cartridge for Chaco Liner Pen Style (Silver)



NET: 2.5 g approx.

Easy Replacement



1 pc./pack 3 packs/box
Package Size 19 x 5.5 x 1.5 cm

Marking Tools

Powder chalk.
Chaco Liners are perfect for drawing thin lines.
Wheel tip for accurate marking on fabric.



469/B
Chaco Liner (Blue)

0 51221 51471 5

469/P
Chaco Liner (Pink)

0 51221 51470 8

469/W
Chaco Liner (White)

0 51221 51472 2

469/Y
Chaco Liner (Yellow)

0 51221 51469 2

1 pc./pack	3 packs/box
Package Size	15.5 x 7.5 x 2 cm



NET: 2.2 g approx.



Powder chalk refills for Chaco Liners.



NET (1 pc.): 2.8 g approx.

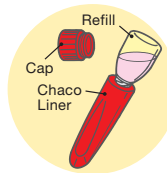

470/B
Chaco Liner Refill (Blue)

0 51221 51481 4

470/P
Chaco Liner Refill (Pink)

0 51221 51480 7

470/W
Chaco Liner Refill (White)

0 51221 51482 1

470/Y
Chaco Liner Refill (Yellow)

0 51221 51483 8

2 pcs./pack	3 packs/box
Package Size	10.5 x 6.5 x 2.3 cm

Tailor's Chalks available in four colours.



Size: 30 x 25 cm

434
Tracing Paper "Clover Chacopy"

0 51221 51343 5

5 sheets/pack	3 packs/box
Package Size	32.5 x 12.5 x 0.4 cm

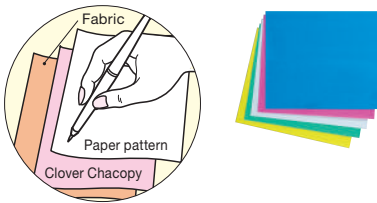

432/B
Triangle Tailor's Chalk (Blue)

0 51221 51215 5

432/W
Triangle Tailor's Chalk (White)

0 51221 51217 9

432/Y
Triangle Tailor's Chalk (Yellow)

0 51221 51218 6

432/R
Triangle Tailor's Chalk (Red)

0 51221 51216 2

1 pc./pack	3 packs/box
Package Size	8.5 x 6.5 x 0.9 cm



432/B 432/W 432/Y 432/R

Marking Tools

Marking tool use and method of erasure

★ Make sure to always test the tools (by marking and erasing) on an edge of the cloth before use.

⊙=optimal / ○=suitable/△=usable

Art No.		5030, 5031, 5032	515, 516, 5013	517	418	5000, 5001, 5002, 5003
Product image						
Usage	Sewing	⊙	⊙	⊙	⊙	⊙
	Patchwork	○	○	○	○	○
	Embroidery	○	○	○	○	○
Method of erasure	Disappears over time	⊙ 4 to 14days*				
	Spray with water	⊙	⊙			○
	Wash with water	⊙	⊙	⊙	△	⊙
	Use an erasing pen	⊙	⊙			
	Heat from an iron			⊙		
	Use a brush				△	
Remarks		- Pen type - For white and light-colored fabric * Art No. 5030 markings will disappear in about 2 to 7 days.	- Pen type - For white and light-colored fabric	- Pen type - For black and dark-colored fabric	- Pencil type	- Pencil type - A soft lead makes it is easy to apply - Can also be used on felt

Art No.		4710, 4711, 4712, 4713, 4714	469/B, 469/P, 469/W, 469/Y	432/B, 432/W, 432/Y, 432/R	434	5004, 5005
Product image						
Usage	Sewing	⊙	⊙	⊙	⊙	Applique, stuffed animals
	Patchwork					
	Embroidery				○	
Method of erasure	Disappears over time			Does not disappear		Does not disappear
	Spray with water					
	Wash with water	△	△		⊙	
	Use an erasing pen					
	Heat from an iron					
	Use a brush	△	△			
Remarks		- Powder type - Avoid heat sources such as ironing	- Powder type - Avoid heat sources such as ironing	- Avoid heat sources such as ironing		- Pencil type - For white and light-colored fabric



Sewing & Patchwork Accessories

For more efficient craftwork!

Amazing pressing force with just a little effort!

The Roll & Press is a quick and efficient way to make creases or to open and fold seam allowances.

Quick, portable, ergonomic.



7812	
Roll & Press	
	
0 51221 73000 9	

1 pc./pack	3 packs/box
Package Size	21 x 8 x 3 cm

Roll to press a seam or fold, either straight, curved or paper pieced seams.



Convenient in these situations too!

- For laminates and other fabrics that cannot be ironed
- For foundation piecing (paper piecing) and machine piecing
- For making a crease before ironing

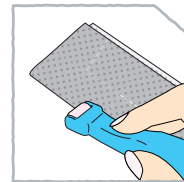

• Crease fabric

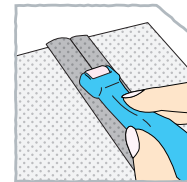

• Fold seam allowance
• Open seam allowance

Fabric and hand-friendly.

A roller that glides smoothly

- Doesn't pull or distort fabric
- Allows you to press fabrics along straight or curved lines

Quick, portable, ergonomic

- Can be held in most comfortable position - left or right handed
- Just a little downward force is all that is needed for significant pressing action.

Press small areas with accuracy

- The roller's slight arc allows you to focus pressure on precise areas
- Roller edges will not leave creases on the fabric

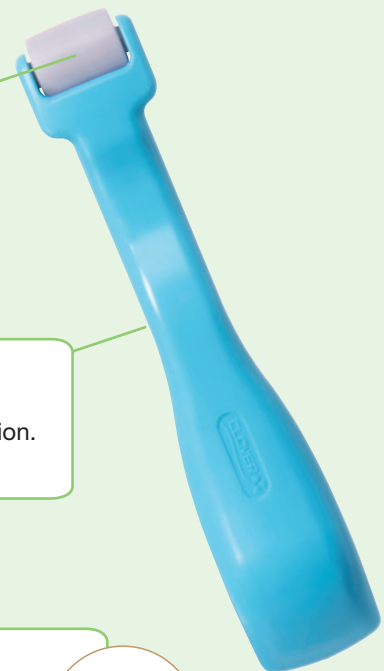

Sewing & Patchwork Accessories

Suitable for making creases and opening and folding the seam allowance of a piece.



495 Finger Presser	
1 pc./pack	3 packs/box
Package Size	19 x 4.5 x 1 cm

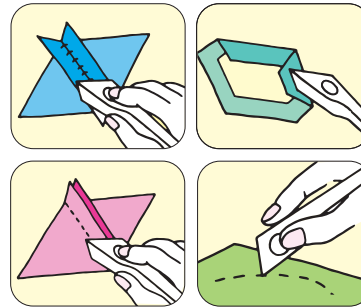

Perfect for foundation piecing, patchwork and appliqué. Made from abrasion-resistant durable material.

The ideal shape of the spatula and the extra thin tip useful in folding are perfect for appliqué.



4002 "HERA"™ Marker for Appliqué & Sewing	
1 pc./pack	3 packs/box
Package Size	21 x 4.5 x 0.9 cm

Usage examples of the spatula

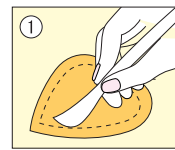

This marker is easy to use for appliqué work and creasing.

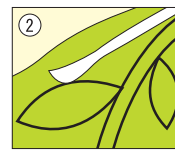

For making marks on appliqué and reverse appliqué



Extra thin tip with curved design.

Usage example of the sharp tip

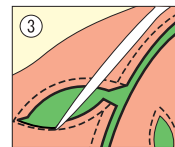

For folding appliqué and reverse appliqué

Used for marking and creasing on fabric.



490/NV "HERA"™ Marker	
1 pc./pack	3 packs/box
Package Size	19 x 4.5 x 0.8 cm



An easy grip, easy press spatula

Sewing & Patchwork Accessories

A sewing ruler with adequate flexibility.

This ruler is perfect for sewing/knitting drafts or drawing seam lines. Parallel lines can be drawn accurately at several distances. The ruler is made of a flexible material to help measure curved portions. With this ruler, you can clearly read scales even on dark-coloured fabrics and easily draw a true bias line with a 45° line.

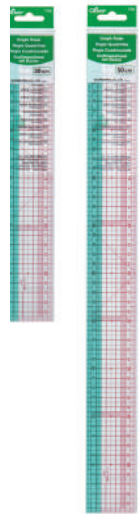
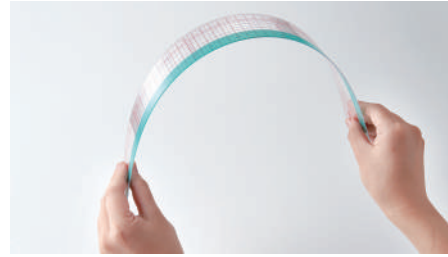

7702
Graph Ruler (30 cm)

1 pc./pack	3 packs/pack
Package Size	33 x 5.5 x 0.1 cm

7703
Graph Ruler (50 cm)

1 pc./pack	3 packs/pack
Package Size	53 x 5.5 x 0.1 cm

Thickness: both 30cm/50cm rulers are 1.0mm thick

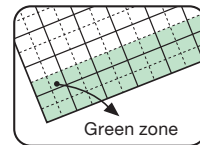

The green zone allows you to read scales easily even on dark-coloured or patterned fabrics.

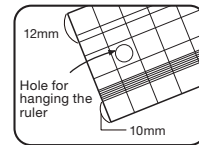

10mm to 15mm parallel lines, which are often used for drawing seam lines, and especially the most popular 12mm parallel line, are separately marked.

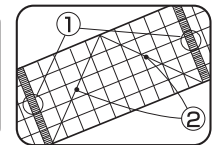

①The two scales subdivided into 1mm divisions just like in the diagram allows you to draw parallel lines accurately. ②The 45° angle line helps to easily and correctly mark the line for cutting on the bias.

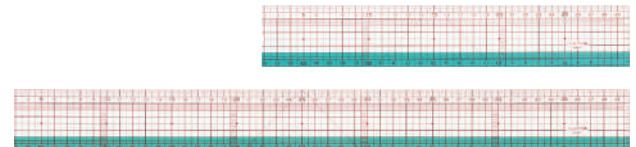

The compact, easy-to-use curve ruler with parallel lines useful for marking seam allowances.

These rulers are optimal for drawing curved lines when copying sewing patterns, creating drafts, or drawing curved seam lines quickly and neatly. Parallel lines are marked along the edge of the curve, enabling the drawing of curved seam lines easily. This is a set of two curve rulers and a mini ruler (15cm).

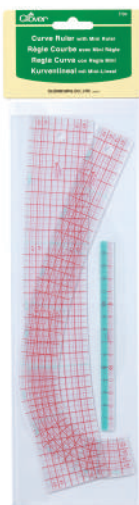

7704
Curve Ruler with Mini Ruler

1 set/pack	3 packs/box
Package Size	39.5 x 11 x 0.4 cm



The rulers come with an attached case.

The green lines show where the radius of curvature changes

Curves perfect for sewing

R=30

R=50

Hanging hole convenient for putting away

7mm/12mm lines often used for sewing

Parallel line markers convenient for drawing seam lines

Hanging hole convenient for putting away

The green lines show where the radius of curvature changes

R=50

R=100

Curves perfect for sewing

Curves perfect for sewing

Deep curve
For the neckline or armhole



Gentle curves
For the hem and hip lines



Mini ruler (15 cm)
For measuring intricate portions

Marked with a 7mm line

The green zone makes scale reading easy even on coloured or patterned fabrics

The green zone is 5mm

Sewing & Patchwork Accessories

This gauge will allow you to quickly mark seam allowances.

Applicable to most seam allowances with a gauge set from 1 to 5cm in 5mm increments.

The gauge is made of metal, so it can be used to make creases using an iron or as a template for creating sharp corners for pockets, etc.



7705
Sewing Gauge

1 pc./pack	3 packs/box
Package Size	16 x 8 x 0.2 cm

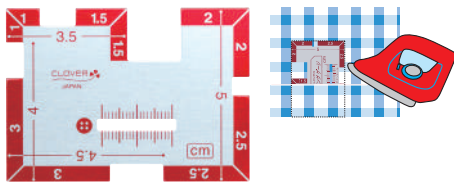

This gauge can also be used when creasing with an iron as it is made of metal.

A gauge in 5mm increments works for most seam allowances.

Comes with a buttonhole guide
Very useful in making marks during drafting.

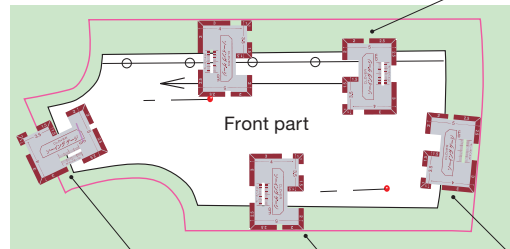

Shoulder seam allowance: 1.5cm

Hem seam allowance: 3.0cm

Side seam allowance: 2.0cm

This sliding gauge is useful in marking seam allowances.

Multipurpose sliding gauge useful for marking.



7706
Sliding Gauge

1 pc./pack	3 packs/box
Package Size	22 x 10.2 x 0.9 cm

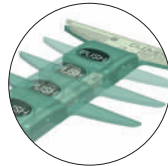

Measurements that can be set:
5-120mm (1mm increments)

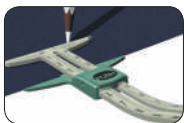

•Hem gauge

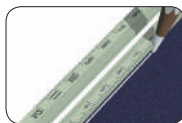

•Seam allowance gauge



•Spacing and marking buttonholes

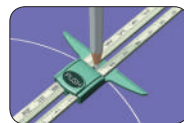

•Compass

Inch gauge



9506
5-in-1 Sliding Gauge

1 pc./pack	3 packs/box
Package Size	23 x 10 x 1 cm

Sewing & Patchwork Accessories

Inch gauge

A multifunctional 11 inch (279.4 mm) sliding gauge for easy marking!

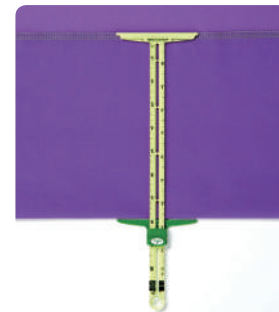
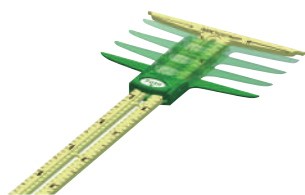

9585 Supersize 5-in-1 Sliding Gauge	

1 pc./pack	3 packs/box
Package Size	37.5 x 11.5 x 1.0 cm

This set of seam markers allows you to neatly draw seam lines along the edges of a pattern/template.

These Seam Markers allow you to draw parallel seam allowances even with a curved pattern or template. Suitable for transferring patterns and templates on appliqué ...and Hawaiian quilts.



7707 Seam Marker Set	
1 set/pack	3 packs/box
Package Size	18.5 x 6.5 x 0.5 cm



Comes in a set of 4 Seam Markers (3mm/5mm/7mm/10mm width).



How to use:

Insert the template/pattern into the groove along the edge of a marker.

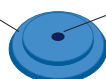

Place the pen tip in the hole.

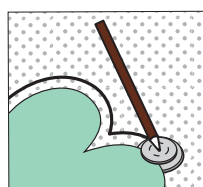

Mark seam allowances of any shape of pattern or template (thickness of 0.6 mm max.).

Roll and draw along the edge of the pattern.

Sewing & Patchwork Accessories

This ruler can simplify three-folding, hemming and cloth wrapping.

Fold, measure, press hems and more in one step.



7700
Hot Hemmer

1 pc./pack	3 packs/box
Package Size	25 x 13.8 x 0.2 cm

Thickness: 1.0mm

For rounded edges of pockets

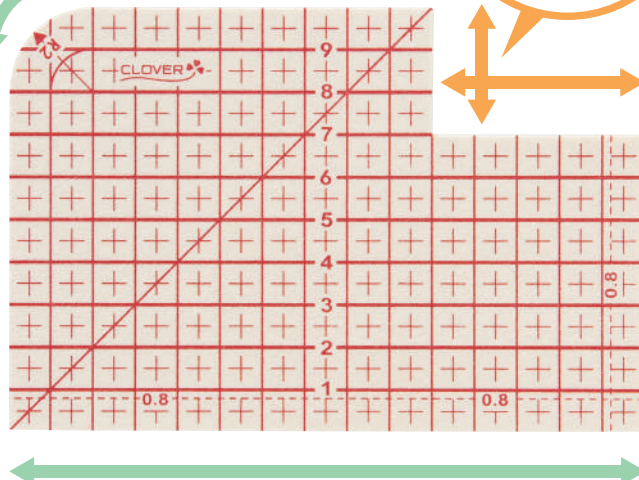
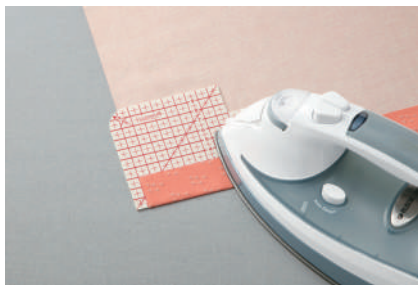
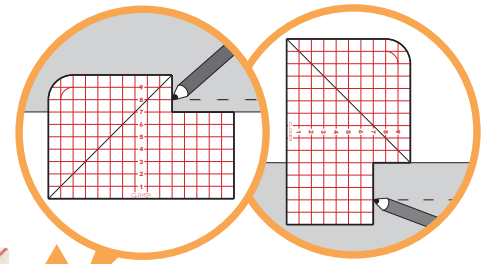

For folding fabric over a gentle curve (Hemming of skirts)

For folding fabric over a long straight line (Hemming of shirts, pants, and more)

Convenient for folding fabric over a long straight line or a curve

This long version of the Clover Hot Hemmer can simplify three-folding, hemming and cloth wrapping. Measure, mark, fold, press: deep hems, long hems.



7701
Hot Hemmer (Long)

1 pc./pack	3 packs/box
Package Size	31 x 9.8 x 0.2 cm

Thickness: 1.0mm

For long straight lines!
25cm long

For small parts!



Cuffs

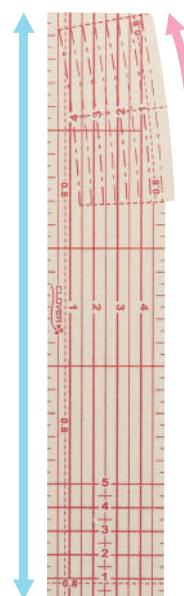

Curved side

For curves!



Skirt hems

You can fold over a curve by using two sides.

*There are curves this ruler cannot hem.

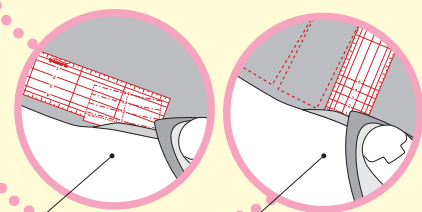

By using the short side...

Short side

By using the curved side...



Sewing & Patchwork Accessories

Thread both large-sized and small-sized needles easily and flawlessly.

You can easily thread needles of any size by inserting them into the same place and pressing a button. Most of Clover Needles (0.51-0.89mm) for sewing and patchwork can be threaded.

Choose Clover Needles for smooth threading!



4071

Desk Needle Threader (Purple)



1 pc./pack

3 packs/box

Package Size

14.6 x 11 x 2.8 cm

4072

Desk Needle Threader (Green)



1 pc./pack

3 packs/box

Package Size

14.6 x 11 x 2.8 cm

4073

Desk Needle Threader (Pink)



1 pc./pack

3 packs/box

Package Size

14.6 x 11 x 2.8 cm

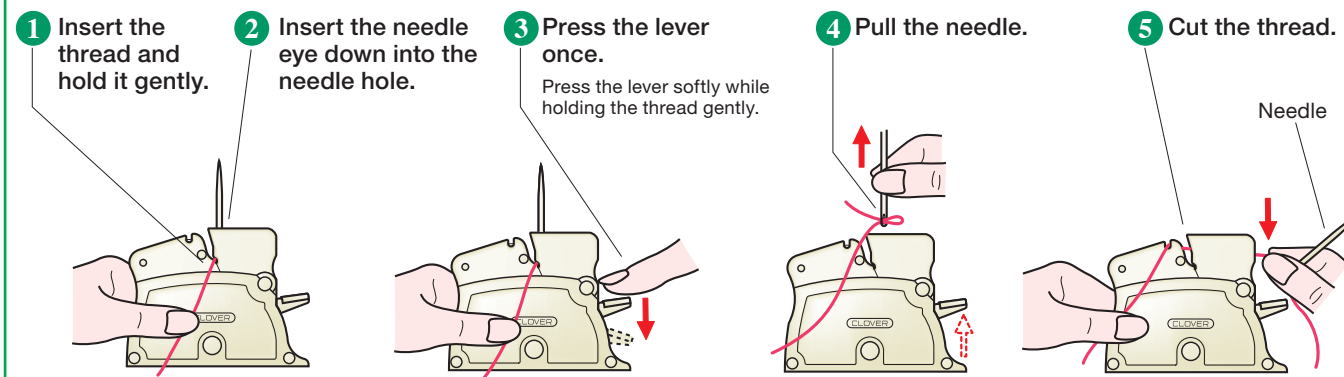

Caution: If the thread does not go through, place the needle down and repeat the procedures **1** to **4**.

<Cautions for use>

- Make sure the thread thickness is applicable to the size of the needle.
- When the thread is pushed through the eye of the needle with too much force, it may be damaged. In this case, pull thread through the eye and cut off the damaged part.
- To store this product, remove needle.

Sewing & Patchwork Accessories



478
Threader with Cutter "PETIT CUT"

2 pcs./pack	3 packs/box
Package Size	10.5 x 6.5 x 0.7 cm

Threader and cutter in one.

How to use:

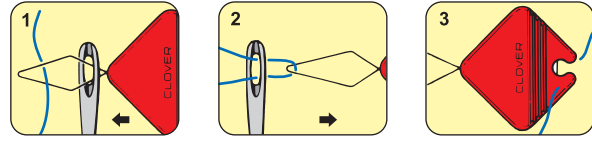

466
Quilt Needle Threader

1 pc./pack	3 packs/box
Package Size	10.5 x 6.5 x 0.5 cm

Antique gold Quilt Needle Threader used for threading fine needles.

How to use:

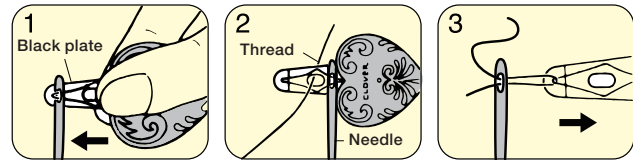

- (1) Insert the wire on the black plate into the needle eye.
- (2) Insert the thread through the wire and the hole in the black plate.
- (3) Pull the needle off the wire.

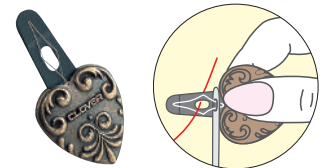

462/NV
Double Needle Threader

1 pc./pack	3 packs/box
Package Size	15.3 x 4.2 x 0.7 cm

Thread both large-sized and small-sized needles.

How to use:

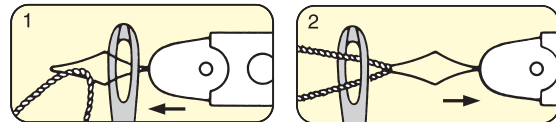

Eye-catching design with new functions.

Threader specially designed for embroidery threads (embroidery needles).



8611
Embroidery Threader

1 pc./pack	3 packs/box
Package Size	15 x 5.5 x 0.8 cm

Comes with a cap



Embroidery Threader has a "Flat tip" for easy and smooth threading even with thick threads.

Thread even thick threads smoothly

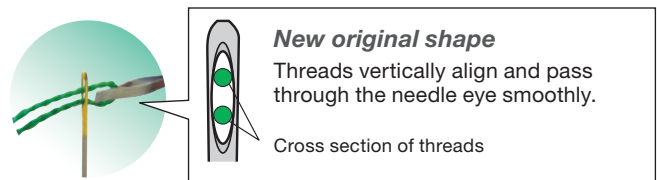

*Please use the designated number and types of threads for each embroidery needle.

Sewing & Patchwork Accessories

"Quick Cut" Thread Cutter

The "Quick Cut" Thread Cutter allows you to quickly and easily separate your quilt chain pieces.



7490
"Quick Cut" Thread Cutter

1 pc./pack	3 packs/box
Package Size	14 x 6 x 4 cm



You can move the blade 12 positions to get a new blade edge.



Our unique design protects your fingers when you set and cut the thread.



* It features Clover's 45mm Rotary Cutter blade which can be replaced.



415
Thread Clipper "KUROHA"

1 pc./pack	3 packs/box
Package Size	18.5 x 7.5 x 1.3 cm

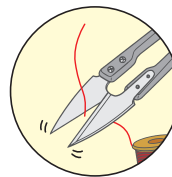

High quality precision clipper with excellent sharp cutting edge.



454
Thread Cutter Pendant (Antique Silver)

455
Thread Cutter Pendant (Antique Gold)

1 pc./pack	3 packs/box
Package Size	10.5 x 6.5 x 0.9 cm



The thread cutter pendant has a built-in sharp circular blade to cut threads. It can be set on top of a thread wheel or used as a pendant. Available in antique silver & antique gold.

Sewing & Patchwork Accessories

You can store threaded needles by winding them onto the reel.



625	
Dome Threaded Needle Case	
1 pc./pack	3 packs/box
Package Size	16.5 x 10 x 3 cm

Store 10 threaded needles neatly!



How to use:
(1) Insert the threaded needle into the groove.

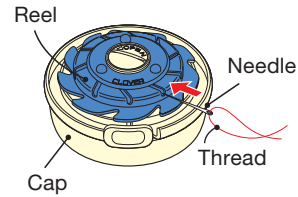

(2) Rotate dome to wind the thread.

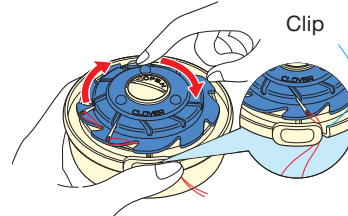

(3) To remove the needle, hold the dome and pull the needle slowly.

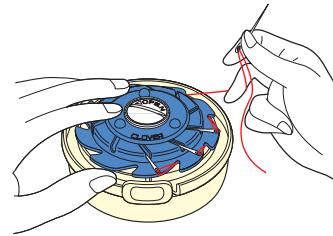

Magnet Pin Caddy

Drop needles on the Magnet Pin Caddy and it will catch and store them in the same direction with its magnetic force.



4105	
Magnet Pin Caddy (Bordeaux)	
1 pc./pack	3 packs/box
Package Size	18.5 x 12 x 4 cm



The Magnet Pin Caddy comes with fine and smooth Clover Silk Pins (10 pins) for trial.

Center groove makes picking up pins from caddy easy.
Includes cover for safe and easy storage, and allows for stacking caddy.
Multiple caddies can be stacked for storage.



Sewing & Patchwork Accessories

Sweet 'n Sharp Macaron

Cute magnetic needle holder & Needle sharpener.

- Catch needles on magnetic surface.
- Polish needles with cream filled cushion.
- Needles sharpened regularly penetrate smoothly the fabric.



4130

Sweet 'n Sharp Macaron (Raspberry)



1 pc./pack

3 packs/box

Package Size

12 x 6 x 2.3 cm

4131

Sweet 'n Sharp Macaron (Pistachio)



1 pc./pack

3 packs/box

Package Size

12 x 6 x 2.3 cm

How to polish needles

1. Insert the needle slowly into the central filling cushion part.
2. Hold the upper and lower sides of the macaron.
3. While checking the polishing condition, insert and pull out the needle several times.



9582

Clip 'n Glide Bodkin



1 pc./pack

3 packs/box

Package Size

23 x 7.3 x 1.1 cm

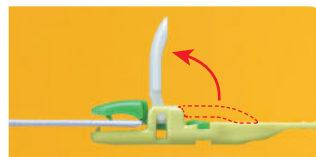

- Clip provides firm hold on elastic end for pulling through casing with ease.
Suitable elastic width: 5/8 in. (15 mm) or wider
Width of casing opening: 3/4 in. (20 mm) or wider
- Exceptional flexibility ensures smooth passage along curvy areas.



4001

Bodkin (2 Types)



2 pcs./pack

3 packs/box

Package Size

12.6 x 5 x 0.7 cm

For threading of ribbon and elastic tape.

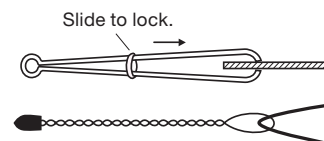

Sewing & Patchwork Accessories

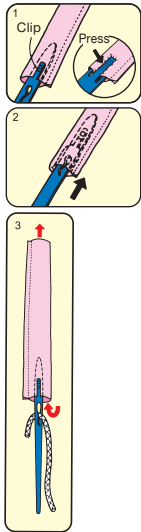

472	
Easy Loop Turner	
2 pcs. (2 sizes)/pack	3 packs/box
Package Size	33 x 4.5 x 0.4 cm



For turning loops inside out.
The loop can be used to insert cording by tying it to the hole.
(See illustration 3.)



4910	
Soft Touch Thread Pick	
1 pc./pack	3 packs/box
Package Size	19 x 4 x 1.0 cm

- The perfect tool for hiding or removing stray threads
- Easily slips through the top fabric, leaving no marks or punctures
- Ideal for long-arm quilters and machine embroidery

Steel tip



Optimal shape for grabbing thread!



4052	
Loop Pressing Bars	
5 pcs. (5 sizes)/pack	3 packs/box
Package Size	34 x 11 x 0.5 cm

Easily make loops, 3D appliqué and Celtic designs.
Seam allowance can be pressed with iron.
The loop can be used to insert cording by tying it to the hole.

Available widths:
6, 9, 12, 15, 18 mm

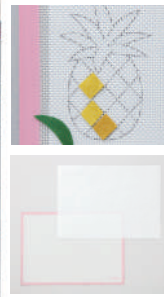

4095	
Design Pro Appliqué Mat	
1 pc./pack	3 packs/box
Package Size	32.5 x 6.4 x 4.6 cm

- Non-slip surface texture holds appliqué pieces in place.
- Transparent mat ensures precision placement.
- Non-stick surface texture allows repeated use of fusible materials.

Contents:
Appliqué mat: 1
Pressing sheet: 1

Instructions for appliqué:



Trim fused fabric into desired shapes.



Place design under mat and assemble fused pieces.



Press pieces in place using pressing sheet.



Remove appliqué from the mat.

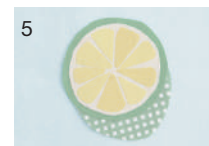

Place the appliqué on base fabric and press.

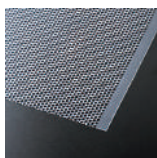

474	
Mesh Transfer Canvas	
1 pc./pack	3 packs/box
Package Size	39 x 7 x 1.4 cm

The sheet of fine mesh is useful for transferring quilt lines and appliqué design layouts.
By using the mesh you don't have to cut out the shape you want to use and trace around.

30 x 40 cm

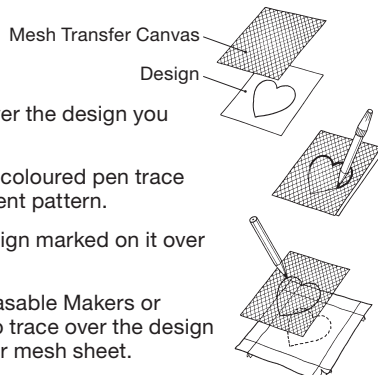

How to use:

- (1) Place the mesh sheet over the design you wish to use.
- (2) Using a ballpoint pen or coloured pen trace the design for a permanent pattern.
- (3) Place the mesh with design marked on it over your fabric.
- (4) Using Clover's Water Erasable Makers or Chacopel Fine pencils to trace over the design you have marked on your mesh sheet.



Size: 12 mm x 7 m

9505	
Double Sided Basting Tape	
1 pc./pack	3 packs/box
Package Size	13.5 x 7.5 x 1.3 cm

Quickly and easily adheres to fabric, paper or wood.

Sewing & Patchwork Accessories



494/S
Patchwork Templates (Squares/Octagons)

4 901316 860097

7 pcs./pack	3 packs/box
Package Size	18.5 x 13 x 0.8 cm

Basic pattern templates set.
 Templates with openings showing both the seam line and cutting edge.



494/T
Patchwork Templates (Triangles/Hexagons)

4 901316 860080

7 pcs./pack	3 packs/box
Package Size	18.5 x 13 x 0.8 cm

Basic pattern templates set.
 Templates with openings showing both the seam line and cutting edge.

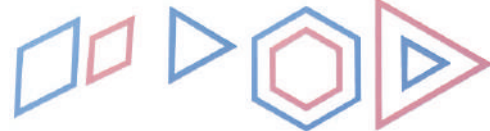

9579
No-Hassle Triangles Gauge

0 51221 79579 4

1 pc./pack	3 packs/box
Package Size	37 x 10 x 1.4 cm

Create 1/2-square or 1/4-square triangle blocks without ever cutting triangles.

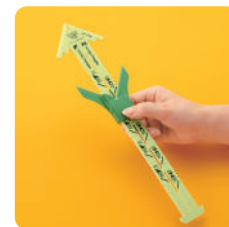

QUICK BIAS <Fusible Bias Tape>

Easily ironed on to straight or curved fabric designs. It will eliminate time consumed in making and pinning it in place. Excellent for use in Stained Glass Quilting, Celtic and Appliqué work or projects.

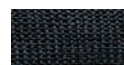

700/1128
QUICK BIAS <Fusible Bias Tape> (Black)

0 51221 50890 5



700/GOLD
QUICK BIAS <Fusible Bias Tape> (Gold)

0 51221 50902 5



700/SILVER
QUICK BIAS <Fusible Bias Tape> (Silver)

0 51221 50903 2

1 pc./pack	6 packs/box
Package Size	10.5 x 8.8 x 0.8 cm

* Actual colours may vary from printed version.

Sewing & Patchwork Accessories

3 functions of marking units, cutting mat, ironing board all in one.



① Japanese Package

57-872
Patchwork Board "MULTI"
 ●mm Gauge

4 901316 578725

1 pc./pack	5 packs/box
Package Size	34 × 27 × 2.5 cm

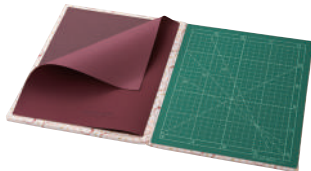

Sandpaper: Easy for marking lines and patterns on fabric, as it prevents it from slipping.

Cutting mat with grid marks(cm) and angle lines.

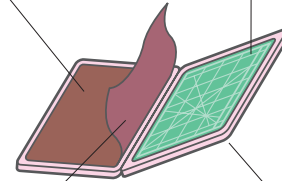

Anti-skid sheet: Holds the ironing board in place and protects the work surface.

Outside(fabric covered): Ironing Board



7803
Point 2 Point Turner

0 51221 77803 2

1 pc./pack	3 packs/box
Package Size	23 × 7.2 × 0.9 cm

Turn every point perfectly.

- Curved end with tip for point turning.
- Fine tipped end for detail work.
- Designed to be comfortable and secure in hand when using either end.



7807
Hold It Precision Stiletto

0 51221 77807 0

1 pc./pack	3 packs/box
Package Size	25.5 × 6.5 × 1.2 cm

Hold while sewing or pressing.

- Grippy tip for holding fabric.
- Angled tip for good reach and visibility.
- Heat resistant silicone tip for working near iron while pressing.

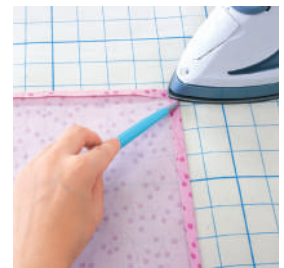



Sewing & Patchwork Accessories

A stitch guide that can be aligned with the edge of the fabric for stitching.

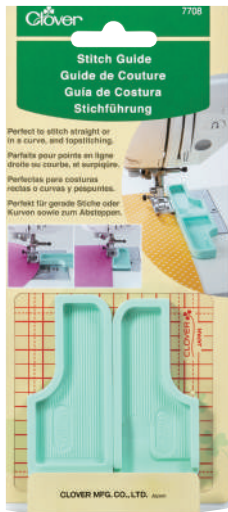

7708	
Stitch Guide	
1 set/pack	3 packs/box
Package Size	18 x 9.4 x 1.2 cm

Comes with a position-adjusting plate!

Now the plate can be kept parallel and the guide can be positioned more easily with a hole for a sewing-machine needle.

The needle goes into the hole.

Stitch guide

Position-adjusting plate

Note:

This guide is suitable for sewing machines of which gap between a needle clamp screw and a needle plate is higher than 8mm.

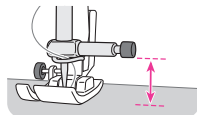

If the stitch guide is aligned with the fabric before stitching with a sewing machine, a neat stitch with a consistent seam-width can be achieved.

The guide comes with an adhesive sheet that can adhere to both metal and plastic surfaces, enabling it to be fixed at any location.

When sewing curved seams



Two guides can be connected and used together

Stitching straight



Use the long side of the guide.



Use both guides connected.

Stitching curves: use the short side of the guide.



inner curve



outer curve

Topstitching: place the guide in front of the presser foot and sew.



Stitching strips: with two guides, you can sew strips neatly.



Sandwich with the two stitch guides

Inch gauge



9584	
Stitch Guide	
1 set/pack	3 packs/box
Package Size	18 x 9.4 x 1.2 cm

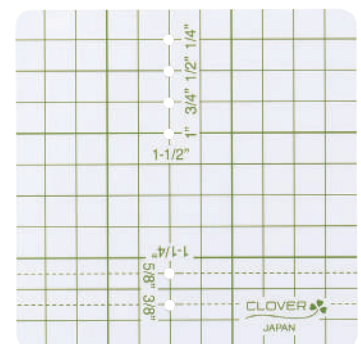

Sewing & Patchwork Accessories

Ideal for Parallel-line stitching.



7709	
Sliding Stitch Guide Foot	
1 set/pack	3 packs/box
Package Size	16.5 x 5.8 x 2.2 cm

This guide foot (presser) is convenient when stitching at regular intervals or stitching parallel lines.

Set your desired width to the ▽ mark. The stitch width can be set between 1 and 7.6 cm at intervals of 1 mm.

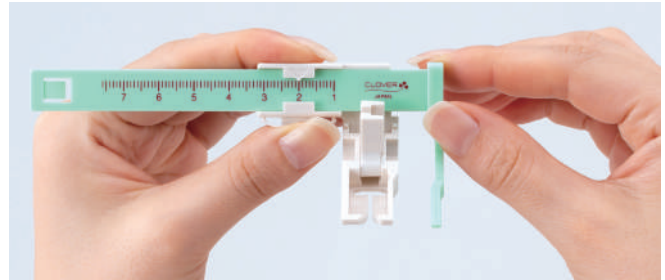

Recommended for quilting

You can sew in line with the stitches you just sewed. This is also convenient when you want to sew a parallel pattern.



Recommended for stitching from the front of the fabric

You can set the stitch width and stitch from the front of the fabric, without having to check the width of folded seams, enabling a clean finish.



Sewing machines compatible with the Sliding Stitch Guide Foot

- Household sewing machines with a low shank
 - * Cannot be used with high-shank machines (industrial and professional-use sewing machines and some high-performance household sewing machines) or slanted needles.
 - * It may require your specific sewing machine company's specialty adaptor. Not compatible with all machines.
- Sewing machines that have a space of approximately 14 mm between the center of the hole in the presser bar and the needle (Figure A)
- Sewing machines with a zigzag stitch width of up to 7 mm

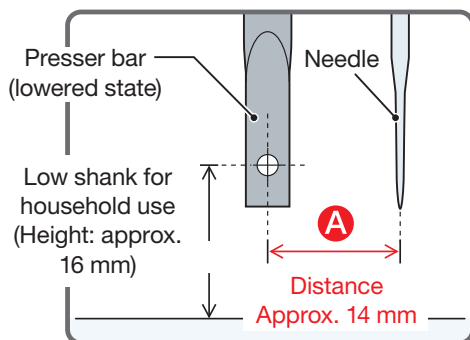

Inch gauge



9586	
Sliding Stitch Guide Foot	
1 set/pack	3 packs/box
Package Size	23 x 9.5 x 2.6 cm



9508	
Stack 'n Store Bobbin Tower	
1 set/pack	3 packs/box
Package Size	11.2 x 7 x 7 cm

- Holds most type of bobbin.
- Secures thread ends - no more tangles!
- See thread colours at a glance!
- Convenient and compact!



Wonder Clips

All you have to do is clip it on and off

Clips to temporarily hold fabric together for sewing <mini>

Narrow tips for precision clipping

- Precision clipping.
- Small and light.
- Works well with sergers.
- As a marking for pieces of fabric.
- Comes with a 5/7/10mm scale.

Maximum
8mm

Small but
opens wide!

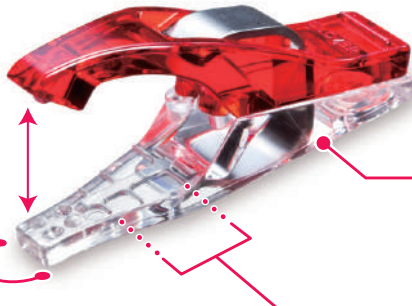

The back of the clip is flat, keeping the fabric down, for easy feeding into the presser foot

Narrow tip with 4
projections to clip tightly!

A guide scale which can estimate seam allowances
in units of 5mm, 7mm and 10mm

When viewing
from the back

Clips can be aligned
with notch marks

5 mm
7 mm
10 mm

When viewing
from the front

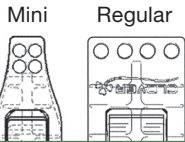

Though small, the Mini Wonder Clips have the same number of projections and clipping power as the regular Wonder Clips.

Mini Wonder Clips

3188



3189



- Great alternative to pins, especially when working with vinyls, piles, and heavy weight fabrics.
- The small size works well with miniature patchwork, doll clothes, and all work that requires holding pieces together in tight sections.
- It is helpful when holding a curved line or for a short distance.
- Easy to see on your work and easy to find when dropped to the floor.

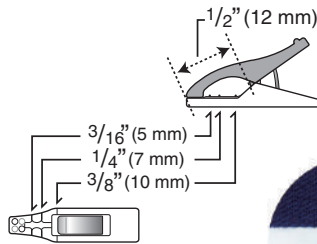

3188	
Mini Wonder Clips (20 pcs.)	
20 pcs./pack	3 packs/box
Package Size 19 x 8 x 1.5 cm	

3189	
Mini Wonder Clips (Assortment/50 pcs.)	
50 pcs./pack	3 packs/box
Package Size 15 x 7.7 x 3.3 cm	



Wonder Clips

All you have to do is clip it on and off



Wonder Clips

- Great alternative to pins, especially when working with vinyls, piles, and heavy weight fabrics.
- Holds layered sections of sewing projects such as, handle connectors to handbags, piping, etc. without distortion.
- Holds quilt binding while sewing.
- Easy to see on your work and easy to find when dropped to the floor.
- Works well with sergers.

Maximum
10mm

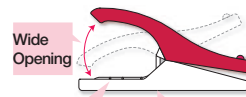

Guide Scale Flat Back

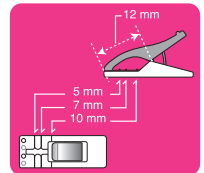

Seam allowance can be estimated in units of 5mm, 7mm and 10mm.



3155



3180



3185

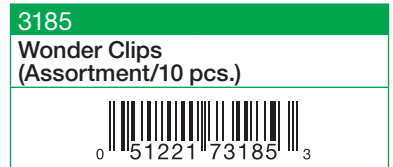
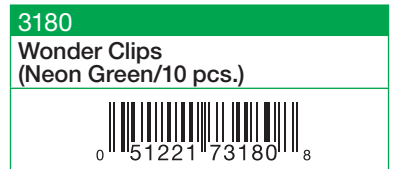
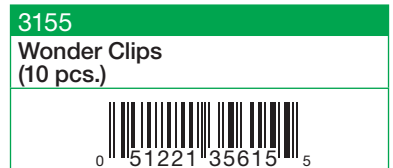

10 pcs./pack	3 packs/box
Package Size	18.7 x 8 x 2 cm



3155/3156/3159

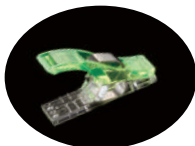

3180



3183/3185

Dressmaking requires many pins.



3156



3183

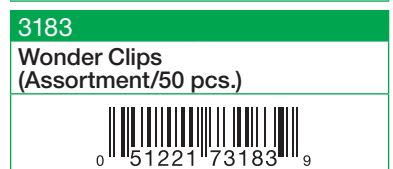
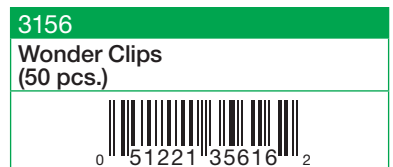

50 pcs./pack	3 packs/box
Package Size	15 x 7.5 x 3.5 cm



Wonder Clips

Perfect for dressmaking which requires many pins to hold fabrics together.



3159	
Wonder Clips (100 pcs.)	
100 pcs./pack	3 packs/box
Package Size	21.5 x 12 x 5 cm



Jumbo Wonder Clips

The clips are useful in holding laminated fabrics, synthetic leathers and other fabrics on which you do not wish to leave holes. The wide opening of the clips are also suitable for holding thick fabrics and zippers.

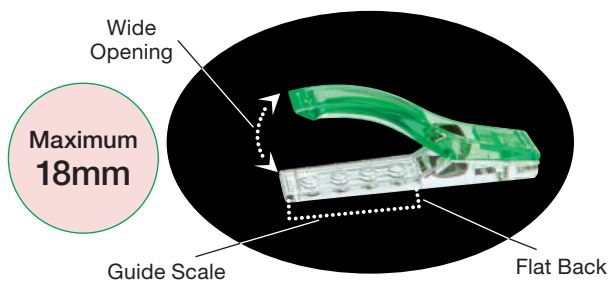

- Clip opens wide to hold layers of fabrics.
- Each clip can hold a length of up to 3cm.
- These clips are convenient for holding wide seam allowances, pouch openings and handles.
- These can be used for patchwork, quilt, knitting and other various handicrafts.
- Flat back for keeping fabrics down, making it easy to use on sewing machines.

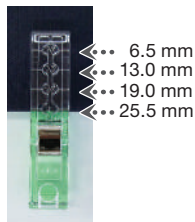

3186/3157

3186	
Jumbo Wonder Clips (12 pcs.)	

12 pcs./pack	3 packs/box
Package Size	20 x 10 x 4 cm



3157	
Jumbo Wonder Clips (24 pcs.)	

24 pcs./pack	3 packs/box
Package Size	21.5 x 12 x 5 cm

Wonder Clips <Variety Pack>

All in one convenient package, each unique clips holds your work in place.



3190	
Wonder Clips <Variety Pack> (26 pcs.)	
26 pcs./pack	3 packs/box
Package Size	20 x 10 x 4 cm

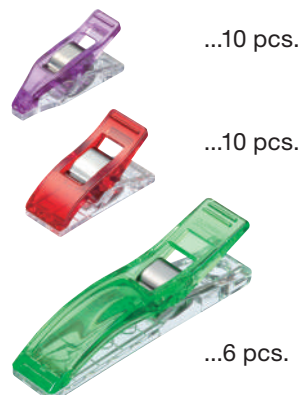

Slash Cutter

Make beautiful slash quilts quickly!



499
Slash Cutter

1 set/pack	3 packs/box
Package Size	22.2 x 9.9 x 1.7 cm

Comes with two interchangeable guides; for straight slash cutting and curved slash cutting. Designed with comfort and safety features!



Straight slash cutting

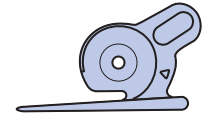

Curved slash cutting

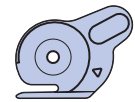

*This cutter only supports Clover's replacement blades.

Quilting method with beautiful layers of colour and soft texture

Making slash quilting fun, beautiful and easy.

Slash quilting is a method of quilting. In this method, multiple layers of fabric are arranged on top of a base fabric and are sewn parallel to the true bias direction. Then, seams of all layers but the bottom layer are cut through and washed, and the fabric of the openings is raised.

Slash quilting is known for its beautiful layers of colour and soft texture. Slash quilting can be done easily and quickly with Clover's Slash Cutter.

Features of Clover Slash Cutter

The ratchet mechanism to firmly fix the blade in place

The ratchet mechanism to prevent the blade from rotating when it is being pushed. As the blade doesn't rotate, the fabric won't get caught in between the blade and the guide, allowing for smooth cutting of several layers of fabric.

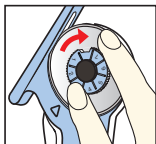

16-step pitch feeding to maintain cutting quality

Turn 1 pitch once the blade becomes dull to improve cutting quality. It is designed so that it is easy to tell when to replace the blade.

The cutter comes with a guides for both straight/curved

It works with both types of slash quilts by switching the interchangeable guides. Both for stitching intervals wider than 6mm.



Insert into a channel between two stitching lines and push forward.



Fabric will be cut as you push the cutter forward.

<Basic technique of slash quilting and how to use a Slash Cutter>

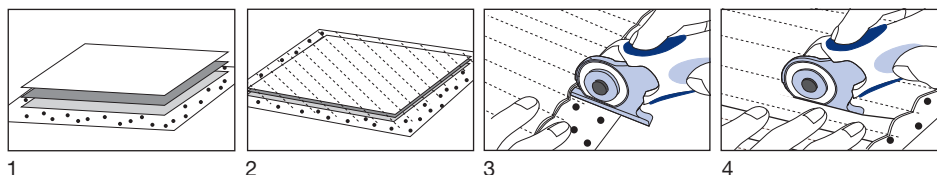

1. Layer pieces of fabric so that the fabric grain is aligned. Select a piece of fabric that has a surface which raises easily as the middle layer, and place a larger piece of fabric as the bottom layer for easy cutting.
2. With a sewing machine, make seams with a fixed width in the true bias direction (in a 45 degree angle to the fabric grain).
3. Insert the Slash Cutter guide in between the seams. (Place the guide on top of the bottom layer.)
4. Hold the fabric down with one hand and push the Slash Cutter forward to cut. (Make a cut with scissors if it is hard to cut at the beginning)
5. Once all the cutting is done, wash with a washing machine and raise fabric. Dry and add the finishing touches to complete.



Scissors

Patchwork Scissors



24 cm

493/L	
Patchwork Scissors (Large)	
1 pc./pack	3 packs/box
Package Size	29.5 x 10.3 x 1.3 cm

Made from top-grade stainless steel, sharp and durable excellent for cutting multiple layers of fabric.



17 cm

493	
Patchwork Scissors	
1 pc./pack	3 packs/box
Package Size	23.3 x 8.3 x 1.2 cm

Perfect for cutting multiple layers of fabric or cutting pieces for quilting. A cover is included for safe and easy handling and storage.



13.5 cm

493/S	
Patchwork Scissors (Small)	
1 pc./pack	3 packs/box
Package Size	18.5 x 6.5 x 1.2 cm

Perfect for cutting appliqué pieces for quilting and sewing.



493/L, 493, 493/S

The finely serrated blades will grip the fabric firmly for a precision cut. Perfect for cutting multiple layers of fabric as well as quilt batting.

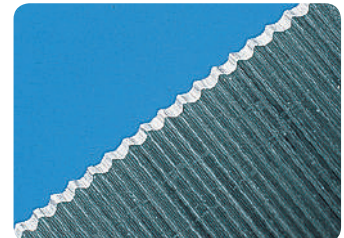

Perfect for fine cutting.



11.5 cm



493/CW	
Patchwork Scissors (Mini)	
1 pc./pack	3 packs/box
Package Size	18.5 x 7.5 x 1.1 cm

The pointed tip is perfect for fine cutting and trimming. Used for chenille quilting, appliqué, sewing and crafts. Heavy duty blades make it easy to cut through several layers of fabric.



Rotary Cutters

Perfect cutter for patchwork requiring accuracy

Rotary cutters are the ultimate in simplicity and functionality. Fits into your hand perfectly and allows for accurate and speedy cuts.

Features of Clover Rotary Cutter

Hold upright



At an angle



- **Cuts beautifully regardless of how you hold it**

Cuts beautifully regardless of how you hold it, whether held upright or at an angle as the cover opens at a tilt, due to the wide cutting range with just the right amount of blade exposed.

- **An easy grip handle that fits into your hand perfectly**

The “Soft Cushion Handle” gently supports your palm and fingers for a comfortable cutting experience. For speedy and accurate cuts with a cutter that fits into your hand perfectly.

***Can be used for both left and right handed users**

Can be used by both right and left hand by simply turning the safety cover around.

*The cutter is initially set to right-hand use.

- **Adjustable rotation speed**

Rotation speed can be adjusted with the tightening screw at the back.

The blade will rotate slower when the screw is tightened allowing for cutting thick or multiple layers of fabric beautifully.

Cover opens at a tilt!

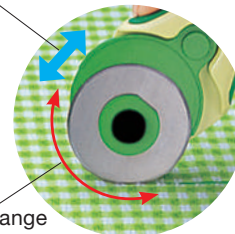

Wide cutting range

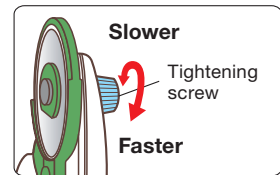

7500	
Rotary Cutter (45 mm)	
1 pc./pack	3 packs/box
Package Size	23 x 12 x 3 cm

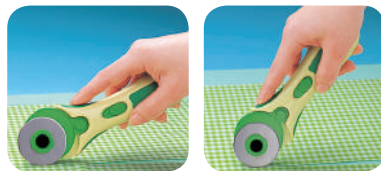

7502	
Rotary Cutter (60 mm)	
1 pc./pack	3 packs/box
Package Size	27 x 12 x 3.5 cm

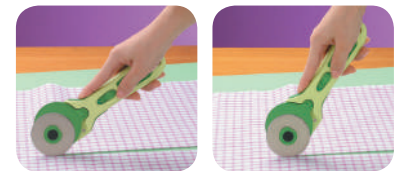

7501	
Rotary Cutter (28 mm)	
1 pc./pack	3 packs/box
Package Size	23 x 10.5 x 3 cm

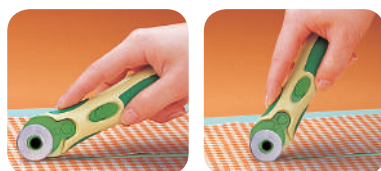

7503	
Rotary Cutter (18 mm)	
1 pc./pack	3 packs/box
Package Size	23 x 8 x 2 cm





Rotary Cutter Blades

Clover Rotary Blade Refills make blade replacement safe, quick and easy.

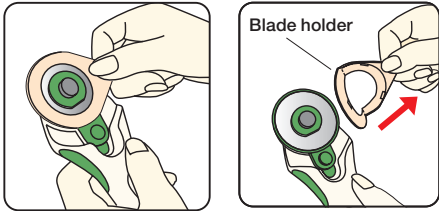

Blades come in a protective cover for safe handling.



45 mm

7508
Clover Rotary Blade Refill
(45 mm/1 pc.)

0 51221 52258 1

1 pc./pack	3 packs/box
Package Size	16 x 7 x 0.3 cm

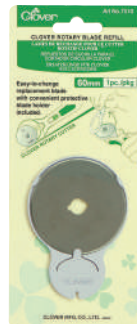

60 mm

7510
Clover Rotary Blade Refill
(60 mm/1 pc.)

0 51221 52266 6

1 pc./pack	3 packs/box
Package Size	20 x 8.5 x 0.5 cm



28 mm

7514
Clover Rotary Blade Refill
(28 mm/2 pcs.)

0 51221 52264 2

2 pcs./pack	3 packs/box
Package Size	16 x 7 x 0.3 cm



18 mm

7512
Clover Rotary Blade Refill
(18 mm/2 pcs.)

0 51221 52268 0

2 pcs./pack	3 packs/box
Package Size	16 x 7 x 1.4 cm



45 mm

7509
Clover Rotary Blade Refill
(45 mm/5 pcs.)

0 51221 52259 8

5 pcs./pack	3 packs/box
Package Size	16 x 8 x 1.8 cm

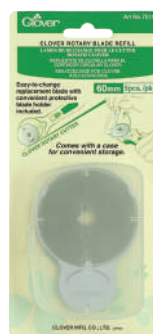

60 mm

7511
Clover Rotary Blade Refill
(60 mm/5 pcs.)

0 51221 52267 3

5 pcs./pack	3 packs/box
Package Size	20 x 9.5 x 1.8 cm



28 mm

7515
Clover Rotary Blade Refill
(28 mm/5 pcs.)

0 51221 52265 9

5 pcs./pack	3 packs/box
Package Size	16 x 7 x 1.4 cm



18 mm

7513
Clover Rotary Blade Refill
(18 mm/5 pcs.)

0 51221 52269 7

5 pcs./pack	6 packs/box
Package Size	16 x 7 x 1.4 cm

Tape Makers

Bias Tape Cutting Ruler

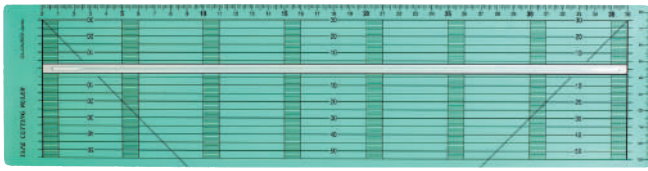

The Bias Tape Cutting Ruler and the Rotary Cutter enable you to cut fabric strips accurately and exactly parallel.

Set the blade of the Rotary Cutter in the slit (wide end) of the Bias Tape Cutting Ruler to cut fabric straight without curving.

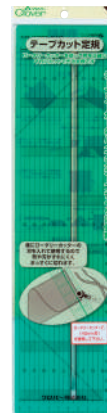
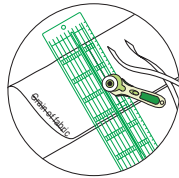

57-924	
Bias Tape Cutting Ruler	
●mm Gauge	
4 901316 579241	

1 pc./pack	5 packs/box
Package Size	43.5 x 11 x 0.4 cm

🇯🇵 Japanese Package

Bias Tape Makers

You can make bias tapes in minutes!

You can quickly make bias tapes of the same width using the same fabric for belt loops and the piping finishing of armholes and necklines.

How to use:

- (1) Cut the fabric according to size.
- (2) Insert the fabric through the tape maker.
- (3) Pin the fabric edge and iron the folded tape as you pull the tape maker.



464/06	
Bias Tape Maker	
(6 mm)	
0 51221 50524 9	
1 pc./pack	3 packs/box
Package Size	17 x 7.5 x 2.1 cm



464/12	
Bias Tape Maker	
(12 mm)	
0 51221 50525 6	
1 pc./pack	3 packs/box
Package Size	17 x 7.5 x 2.6 cm



464/06 464/12 464/18 464/25 464/50
6 mm 12 mm 18 mm 25 mm 50 mm

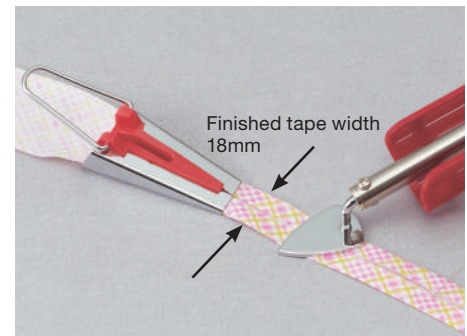

Insert the fabric through the bias tape maker and iron.



464/18	
Bias Tape Maker	
(18 mm)	
0 51221 50526 3	
1 pc./pack	3 packs/box
Package Size	17 x 7.5 x 2.6 cm



464/25	
Bias Tape Maker	
(25 mm)	
0 51221 50527 0	
1 pc./pack	3 packs/box
Package Size	17 x 7.5 x 2.6 cm



464/50	
Bias Tape Maker	
(50 mm)	
0 51221 50528 7	
1 pc./pack	3 packs/box
Package Size	17 x 7.5 x 4 cm



Tape Makers

Fusible Bias Tape Makers

From Celtic Quilt appliqué to temporary piping tapes, this tape maker will expand the creativity of your work.

How to use:

- (1) Insert the Fusible Web (Heat Adhesive Tape) in the upper groove.
- (2) Insert bias cut fabric in the lower groove.
- (3) Pull both materials at the same time and iron.
- (4) Remove the adhesive tape and apply.



Finished tape width 9mm



4011
Fusible Bias Tape Maker
(6 mm)

1 pc./pack	3 packs/box
Package Size	16 x 7 x 2.3 cm

4012
Fusible Bias Tape Maker
(9 mm)

1 pc./pack	3 packs/box
Package Size	16 x 7 x 2.6 cm

By using a 5mm-wide Fusible Web with this 18mm-wide tape maker, you can make bias tapes for piping which can baste fabric.

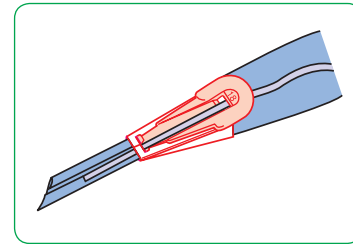

*You can also make bias tapes without heat adhesive tapes.



4013
Fusible Bias Tape Maker
(12 mm)

1 pc./pack	3 packs/box
Package Size	16 x 7 x 3.1 cm

4014
Fusible Bias Tape Maker
(18 mm)

1 pc./pack	3 packs/box
Package Size	16 x 7 x 3.1 cm

4015
Fusible Bias Tape Maker
(25 mm)

1 pc./pack	3 packs/box
Package Size	16 x 7 x 4.1 cm

Fusible Web

This tape is convenient for holding Celtic quilt, stained glass quilt and appliqué in place.



4041
Fusible Web
(5 mm width/25 m roll)

1 pc./pack	3 packs/box
Package Size	14.5 x 11 x 0.8 cm



4042
Fusible Web
(10 mm width/12 m roll)

1 pc./pack	3 packs/box
Package Size	14.5 x 11 x 1.3 cm

Release paper

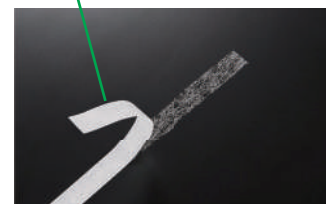

The Fusible Web

The Fusible Web is a heat adhesive tape in the shape of a spider web that will keep the fabric soft and maintain its touch.

Width of the corresponding Fusible Web
6/9mm width: 5mm
12/18/25mm width: 10mm

Mini Iron & Accessories

This small, light iron is very easy to handle and can be used to press small areas.

It features a safety cover and switch on the handle to protect hands and fingers.

Comes with an iron stand



Pilot lamp
You can tell the power is on with one look.

Handy switch
It also features a dial for heat control and an on/off switch on the handle.

Small iron tip
Able to press only the necessary areas.

Thick handle
It fits into your hand comfortably for smooth craftwork.

2-step heat control

Safety cover
Protects hands and fingers coming into contact with the heated conductor.



For continental countries



For UK

Convenient not only for patchwork and quilt but also for sewing and other various handcrafts.



For Celtic quilts



For mesh work



For making appliqué



For folding seam allowance

8003EU

Mini Iron II™ "The Adapter"
(EU Version)

1 set/pack	3 packs/box
Package Size	38 x 13 x 3.5 cm

8004GB

Mini Iron II™ "The Adapter"
(UK Version)

1 set/pack	3 packs/box
Package Size	38 x 13 x 3.5 cm

* The Mini Iron II and related accessories can only be sold to customers living in the above-mentioned countries.

Interchangeable tips are sold separately

Mini Iron II has special interchangeable tips that can be used for Quilting, Sewing and Crafting. The Mini Iron II has four adaptable tips to be used for doll making, paper crafting and hard to reach corners.



The Large Tip works well on large projects.



The Ball Tip is used for Doll Making and General Crafting.



The Slim Line Tip is perfect for working on seams or fabric folding projects.



9103

Adapter Iron Tip (Large)

9104

Adapter Ball Tip

9105



Adapter Slim Line Tip

1 pc./pack	3 packs/box
Package Size	19 x 7 x 1 - 3.2 cm

Embroidery Stitching Tools

Embroider easily by simply thrusting the needle into the fabric!

Enjoy perfectly aligned stitches.

8800	
Embroidery Stitching Tool	
	
1 set/pack	3 packs/box
Package Size	18.5 × 9.5 × 2 cm

*Package includes Embroidery Stitching Tool, one 3-ply needle and one needle threader.

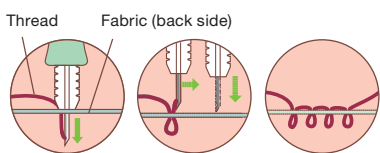

Place the fabric with the design in an embroidery hoop and stitch with a needle as you draw a picture.

Make a variety of stitches by thrusting the needles into the fabric in the same way.

Back stitch



Thrust the needle into the fabric surface.
Thrust needle in the direction of stitching.

Satin stitch

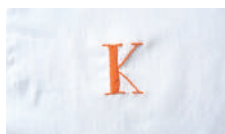

Thrust the needle into the fabric surface.
Thrust needle as if filling the surface.

Loop stitch



Thrust needle from the back of the fabric.
Thrust needle while enjoying the three-dimensional look.

Velvet-like



Thrust needle from the back of the fabric.
Cut the end of the loop with scissors.



8801	
Embroidery Stitching Tool Needle Refill (Single Ply Needle)	
	
1 pc./pack	3 packs/box
Package Size	18.5 × 5.5 × 0.8 cm

8801



1 pc./pack	3 packs/box
Package Size	18.5 × 5.5 × 0.8 cm

8802



8802	
Embroidery Stitching Tool Needle Refill (Needle for Medium-Fine Yarn)	
	
1 pc./pack	3 packs/box
Package Size	18.5 × 5.5 × 0.8 cm

8803	
Embroidery Stitching Tool Needle Refill (6 Ply Needle)	
	
1 pc./pack	3 packs/box
Package Size	18.5 × 5.5 × 0.8 cm

8803



1 pc./pack	3 packs/box
Package Size	18.5 × 5.5 × 0.8 cm

8804



8804	
Embroidery Stitching Tool Needle Refill (3 Ply Needle)	
	
1 pc./pack	3 packs/box
Package Size	18.5 × 5.5 × 0.8 cm

1 pc./pack	3 packs/box
Package Size	18.5 × 5.5 × 0.8 cm



8810	
Embroidery Stitching Tool Needle Threader	
	
2 pcs./pack	3 packs/box
Package Size	20.3 × 4.5 × 0.5 cm

Convenient threader for the Embroidery Stitching Tool.

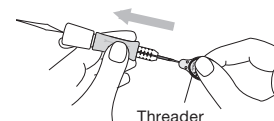

Embroidery Stitching Tools

Perfect for Embroidery Stitching.

Inner hoop grips the fabric firmly, keeping it tight.



8812
Clover Embroidery Hoop
(18 cm)

1 pc./pack	3 packs/box
Package Size	23 x 19 x 1.6 cm

8813
Clover Embroidery Hoop
(12 cm)

1 pc./pack	3 packs/box
Package Size	22 x 13 x 1.4 cm



The Clover Embroidery Hoop consists of an inner and outer hoop.

Tighten hoop by turning metal dial.
Keeps the thread from wrapping around the screw.

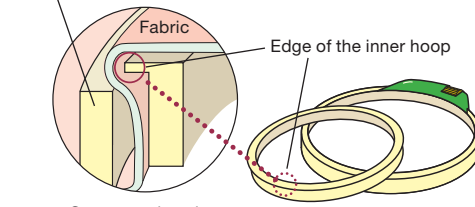

Cross-section view

"Kantan Couture" Bead Embroidery Tools



This old art of embroidery using a fine hook on a fine cloth stretched in frame is called "Tambour", reborn with Clover's "Kantan Couture" Bead Embroidery Tool.

Basic techniques with this tool can create beautiful motifs using sequins and beads. Embellish/Design and make it your own. Your imagination possibilities are endless.



9900
"Kantan Couture"
Bead Embroidery Tool

1 set/pack	3 packs/box
Package Size	22 x 6.5 x 2.2 cm

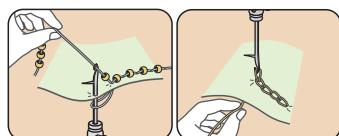

Beads and sequins are easily applied.
Chain-stitching is a breeze.



9901
"Kantan Couture"
Bead Embroidery Tool Needle Refill

1 pc./pack	6 packs/box
Package Size	14 x 6 x 0.2 cm

Replacement needle exclusively for Bead Embroidery Tool.
Easy replacement with a screw on the handle.

Swift Bead

Quick beading needles.

Quickly string your beads with the Swift Bead.
Great to use for crochet and knitting with beads.
Add beaded fringe to your projects, and embellish with beads.



2300	
Swift Bead	
2 pc./pack	3 packs/box
Package Size	15 x 5 x 0.2 cm

- Needle length: 75 mm
- Suitable beads: 15/0 - 11/0
- *Round beads, cylinder beads, etc.

How to use

*Loose beads should be put in a long, narrow container.

1. Put a string through the needle.
2. Move the needle up and down.
3. Pull string through the beads.

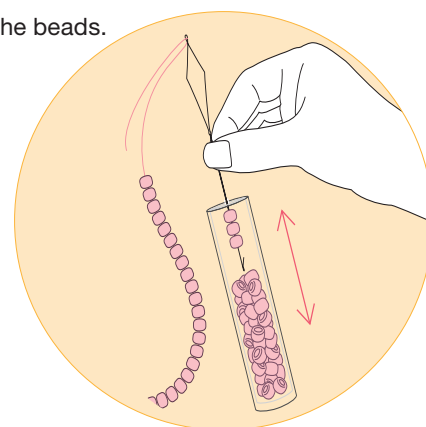

Stitch Dome

For easy and speedy embroidery and hemstitching!



8830	
Stitch Dome	
1 set/pack	3 packs/box
Package Size	14 x 8.8 x 2.1 cm

- Stitch dome x 1
- Rubber x 1

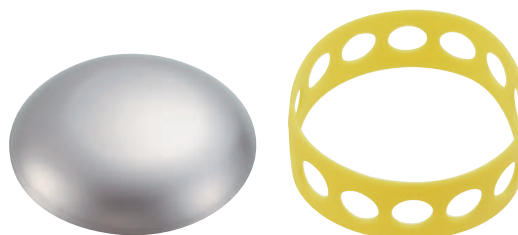

Diameter: approx. 86 mm Height: approx. 17 mm

The secret to its ease of use

The elastic band holds the fabric securely

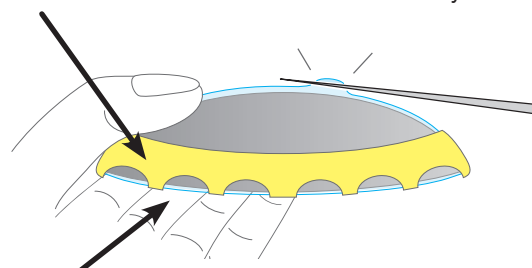

The dome protects your hands from needles

How to use



1. Place the Stitch Dome under the fabric.



2. Fix the fabric with the elastic band, work on your embroidery or hemstitching using the surface of the Stitch Dome.

Embroidery



Appliqué



Sewing



**"Wonder Clips" is not included in the set.

“QUICK” Yo-Yo Makers

Quick and easy Yo-Yo Maker templates!

“QUICK” Yo-Yo Makers allow you to make evenly spaced stitches to create beautiful gathers. Fold the seam allowance, rounding off to make a nicely shaped yo-yo.



Place the fabric between the plates and cut off the seam allowance leaving 3-5mm.



Stitch following the holes in the plates.



Remove the plates and gather the thread.

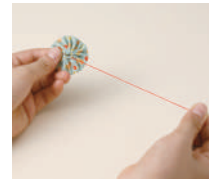

Gather tightly, knot the end and hide it by placing it inside.



Round off to a nice shape and voila!



8702
“QUICK” Yo-Yo Maker (Extra Small)

0 51221 55772 9

1 set/pack	3 packs/box
Package Size	22 x 10.5 x 1 cm



Finished size:
Approx. 20 mm



8700
“QUICK” Yo-Yo Maker (Small)

0 51221 55770 5

1 set/pack	3 packs/box
Package Size	22 x 10.5 x 1 cm



Finished size:
Approx. 30 mm



8701
“QUICK” Yo-Yo Maker (Large)

0 51221 55771 2

1 set/pack	3 packs/box
Package Size	22 x 12 x 1 cm

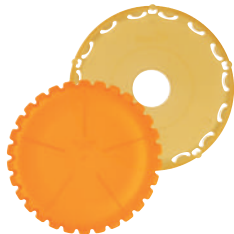

Finished size:
Approx. 45 mm



8703
“QUICK” Yo-Yo Maker (Extra Large)

0 51221 55773 6

1 set/pack	3 packs/box
Package Size	22 x 14.5 x 1 cm

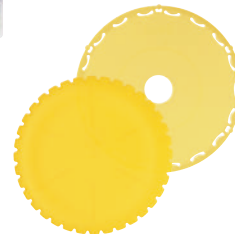

Finished size:
Approx. 60 mm



8708
“QUICK” Yo-Yo Maker (Jumbo)

0 51221 55778 1

1 set/pack	3 packs/box
Package Size	23 x 19 x 1.5 cm

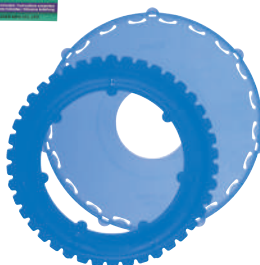

Finished size:
Approx. 90 mm

Kanzashi Flower Makers

Simply set, cut and sew to create beautiful Kanzashi Flowers!

Kanzashi is a traditional Japanese art form of folding and stitching fabric petals for use in beautiful hair adornments.

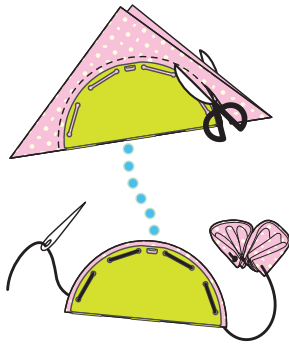

Finished size:
Approx. 50 mm



Finished size:
Approx. 75 mm

8484
Kanzashi Flower Maker
(Gathered Petal/Small Size)

1 pc./pack	3 packs/box
Package Size	22 x 10.2 x 0.7 cm

8485
Kanzashi Flower Maker
(Gathered Petal/Large Size)

1 pc./pack	3 packs/box
Package Size	22 x 11.2 x 0.7 cm



Finished size:
Approx. 75 mm

8483
Kanzashi Flower Maker
(Pointed Petal/Large Size)

1 pc./pack	3 packs/box
Package Size	22 x 11.2 x 0.7 cm



Finished size:
Approx. 50 mm

8486
Kanzashi Flower Maker
(Orchid Petal/Small Size)

1 pc./pack	3 packs/box
Package Size	22 x 10.2 x 0.7 cm



Finished size:
Approx. 75 mm

8487
Kanzashi Flower Maker
(Orchid Petal/Large Size)

1 pc./pack	3 packs/box
Package Size	22 x 11.2 x 0.7 cm



Wonder Knitter

The sweet old spool knitting has come back in a cute design!

The Wonder Knitter is extremely easy to use and you'll never get tired of knitting!

The rotating disk makes knitting easy and fast. A variety of materials can be used, such as beads and nylon string.



3101	
Wonder Knitter™	
1 set/pack	3 packs/box
Package Size	22 x 12.4 x 5.5 cm



The secret of easy knitting is the rotating disc

Turn the disc and the thread will automatically come into place. No need to adjust thread position and tension for easy knitting.



- Contents**
- Main body: 1 pc.
 - Crochet Hook: 1 pc.
 - 3-peg Head: 1 pc.
 - 6-peg Head: 1 pc.



Pick up lower stitch.



Hook over upper yarn onto pin.



Rotate disk and continue.

Change the disc with just one touch!

Use 3 pins to knit a thin cord and 6 pins to knit a thick cord. Knit cords of two different sizes by changing the disc. Easy and quick knitting!

French Knitter

Create dazzling accessories with beads on nylon, yarns, and embroidery threads.



3100	
French Knitter — Bead Jewelry Maker —	
1 set/pack	3 packs/box
Package Size	22 x 12.5 x 3.8 cm

- Contents**
- Main body: 1 pc.
 - Crochet Hook: 1 pc.
 - 4-peg Head: 1 pc.
 - 5-peg Head: 1 pc.
 - 6-peg Head: 1 pc.



3 interchangeable heads included



Flower Loom



Setting a frame on the loom base and mending a thread with the pin are all you need to do make a flower motif!

Enjoy making a variety of motifs through many different frames, combinations and ways of binding and mending!

Create beautiful fun-flowers in every season with wool, yarn, ribbon or raffia in different shapes and sizes. The Flower Loom is the perfect embellishing tool for all ages. The flowers can be joined together to make beautiful wearable art, home decor accessories such as pillows, trimmings, and bags.



3146	
Flower Loom	
1 set/pack	3 packs/box
Package Size	22 x 13 x 5 cm



1. Set the loom on the base.



2. Wind the yarn around the pegs in a criss-cross fashion.

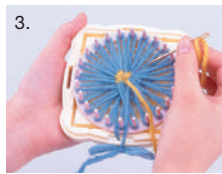

3. Weave the yarn around each petal to make the center.



4.



Connect motifs to make a bag!



Accentuate your needlework with a corsage!

Bracelet Maker

Make decorative bracelets by knotting and weaving threads.

Create 8 different bracelet styles with a variety of decorative yarns, threads and beads.

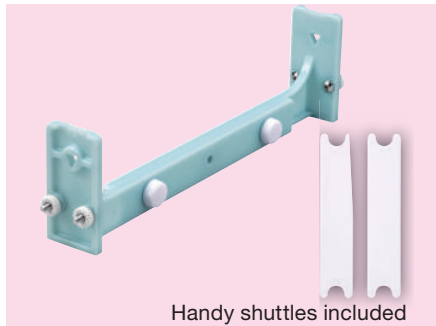

Handy shuttles included

9943	
Bracelet Maker	
1 set/pack	3 packs/box
Package Size	26 x 6.4x 3.4 cm

You can make your favorite bracelet combining the techniques you choose for each of Part-A and B.



Enjoy 8 creative style variations.

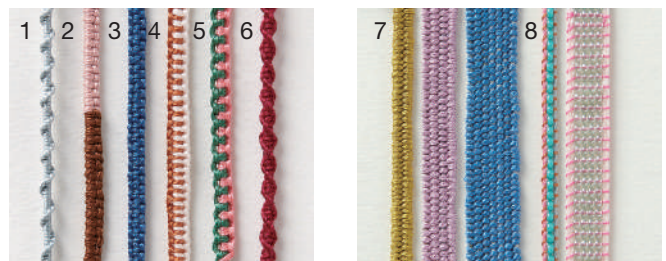

Knotting

Weaving

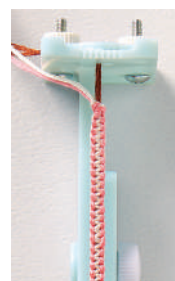
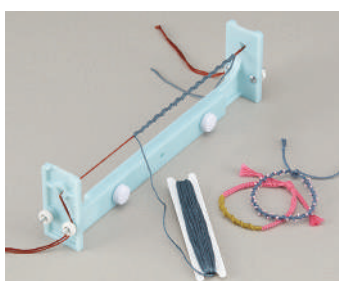

Pom-Pom Makers

Beautiful Pom-Poms Made Easy!

The measuring scale on the arch makes it easy to create multi-colored pom-pom.

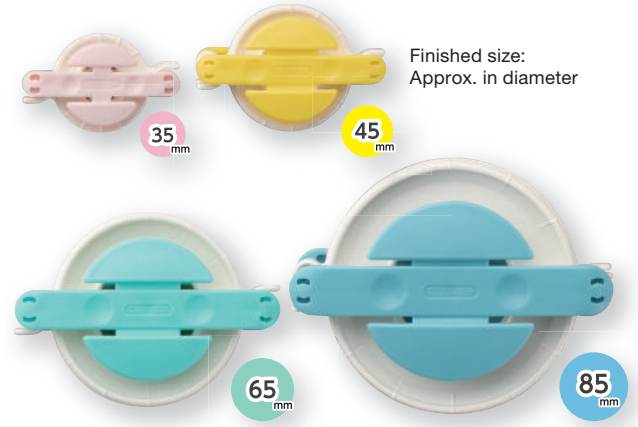
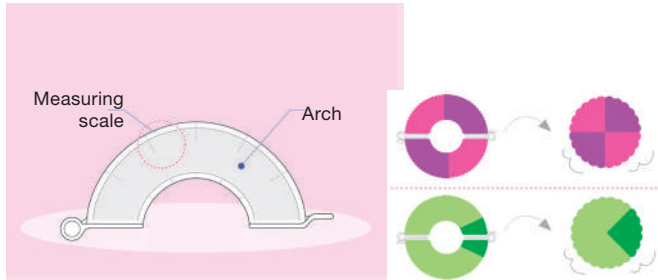

1. Wind the yarn.



2. Cut the yarn.



3. Tie with thread.



4. Open one arch at a time.



5. Remove Pom-Pom Maker.



6. Trim loose ends to shape.



3129
Pom-Pom Maker Set

0 51221 73129 7

4 pcs./pack	3 packs/box
Package Size	22 x 13 x 3.7 cm

Includes 4 Pom-Pom Makers in different sizes with new specifications!
Finished size: Approx. 35/45/65/85 mm in diameter



3124
Pom-Pom Maker (Small)

0 51221 35679 7

2 pcs./pack	3 packs/box
Package Size	16.5 x 8 x 3.2 cm

Finished size: Approx. 35 / 45 mm in diameter



3126
Pom-Pom Maker (Large)

0 51221 35680 3

2 pcs./pack	3 packs/box
Package Size	22 x 10.5 x 3.5 cm

Finished size: Approx. 65 / 85 mm in diameter





Pom-Pom Makers



3127
Pom-Pom Maker (Extra Small)



2 pcs./pack	3 packs/box
Package Size	16.5 x 7 x 2.5 cm



Finished size:
 Approx. 20 mm
 in diameter

Finished size:
 Approx. 25 mm
 in diameter



3128
Pom-Pom Maker (Extra Large)



1 pc./pack	3 packs/box
Package Size	22 x 14 x 5.5 cm



Finished size:
 Approx. 115 mm
 in diameter

Tassel Makers



How to use



Create tassels with your favorite threads!
 Easily make tassels with embroidery thread, woolen yarns and others.

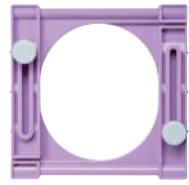

9940
Tassel Maker (Small)



1 pc./pack	3 packs/box
Package Size	22 x 14.5 x 2 cm

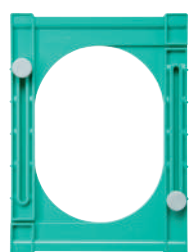

9941
Tassel Maker (Large)



1 pc./pack	3 packs/box
Package Size	22 x 16 x 2 cm

Hair Pin Lace Tool

Easily braid scarves, chokers, stoles, and so on.

Change blade width with the pin position.

As the ends clip on and off:

You can quickly make long braids without any interruption.

“Hair Pin Lace” is a traditional interwoven braid that can be made using a basic technique known as “single crochet”. Make braid widths: 2 - 8 cm. You can set every 1 cm.

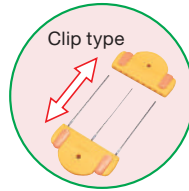

With 3 pins:

Set a third pin in the middle for an even more beautiful braid. As there are holes in the pin, you can pass other threads through the braid while braiding. This lace tool can even be used for a variety of purposes, including connecting braids and make gathers.

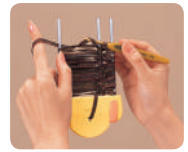

How to use:

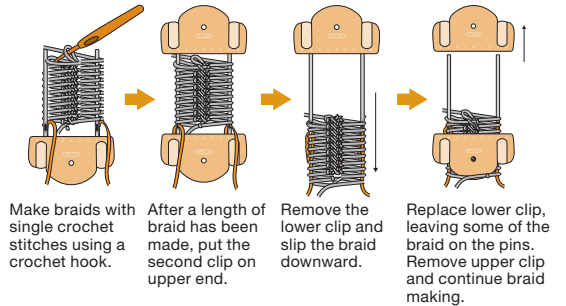

3104	
Hair Pin Lace Tool	
1 set/pack	3 packs/box
Package Size	22 x 15 x 1.8 cm

Needle Felting Tools



8901	
Pen Style Needle Felting Tool	
1 set/pack	3 packs/box
Package Size	22 x 9.5 x 3.5 cm

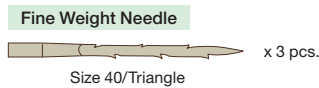

For small and delicate felt projects using 1, 2 or 3 needles.

- 3 needles For a quick finish
- 2 needles For creating lines and outlines
- 1 needle For delicate work



8900	
Needle Felting Tool	
1 set/pack	3 packs/box
Package Size	22 x 9.5 x 3.5 cm

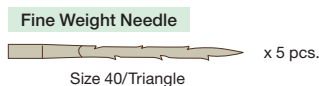

No thread or glue needed! Clover's Needle Felting Tool has five barbed needles that catches the wool roving fibers and pushes them into the bottom of the fabric. The wool roving fibers stay permanently without using glue or sewing it. The tool comes with a clear lock cover for safety and storage.

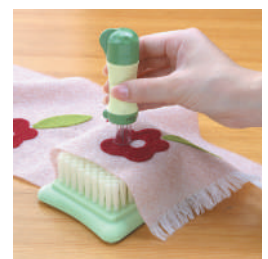

8905	
Needle Felting Tool Refill Needle (Fine Weight Needle)	

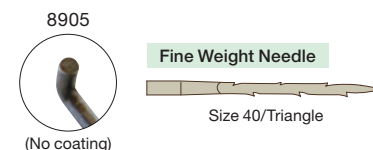

8906	
Needle Felting Tool Refill Needle (Heavy Weight Needle)	

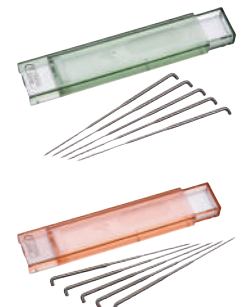
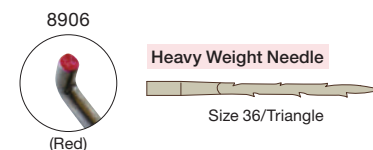

Replacement needle for Needle Felting Tool and Pen Style Needle Felting Tool.



Needle Felting Tools

The brush-like mat enables smooth punching with little resistance, and allows the fibers of the appliqué to become well meshed with the basic fabric.



8910
7 x 9 cm

8910	
Needle Felting Mat (Small)	
1 pc./pack	3 packs/box
Package Size	23 x 14 x 6 cm



8911
8 x 13 cm

8911	
Needle Felting Mat (Large)	
1 pc./pack	3 packs/box
Package Size	24.8 x 14.5 x 6 cm



8919	
Claw and Mat Cleaner	
1 pc./pack	3 packs/box
Package Size	22 x 9.5 x 3.5 cm



Holds small motifs in the desired position.



Blends wool roving colours together.



Cleans out fibers to the roots of the Needle Felting Mat.

Natural Wool Rovings



100% Wool
Net: approx. 20g

7920-7939	
Natural Wool Roving	
1 pc./pack	3 packs/box
Package Size	18 x 14 x 5.5 cm

For Needle Felting, Pom-Pom Makers and other yarn crafts.

	7920 Off White			7929 Gold	
	7921 Lime Green			7931 Brown	
	7922 Moss Green			7932 Black	
	7923 Blue			7933 Ash	
	7926 Pink			7935 Caramel	
	7927 Red			7939 Light Blue	

Tatting Shuttles



479
Tatting Shuttle

2 pcs./pack	3 packs/box
Package Size	15.5 x 7.5 x 1.3 cm

* Assorted 2 pcs. from these 5 colours.



8107
Spare Bobbin Set (White)

1 set/pack	3 packs/box
Package Size	18.5 x 8.0 x 1.5 cm

8108
Spare Bobbin Set (Brown)

1 set/pack	3 packs/box
Package Size	18.5 x 8.0 x 1.5 cm

Spare Bobbin sets are for exclusive use with Bobbin Tatting Shuttles.

This case can store a set of tatting shuttles and bobbins.



8109
Storage Case for Bobbin Tatting Shuttle

1 set/pack	3 packs/box
Package Size	21 x 11 x 3.2 cm



8110
Storage Case for Tatting Shuttle

1 set/pack	3 packs/box
Package Size	21 x 11 x 3.2 cm



This case can store tatting shuttles including L size.

Picot Gauge Set



- A set of 7 (1/2/3/5/7/10/13mm)
- Consecutive picots can be made easily.
- As the gauges have no sharp corners, picots can be beautifully finished with round edges.



How to make consecutive picots:

Place the thread on the left hand in front of the gauge and make knit stitches.

Pull it to the bottom of the gauge and slide it to the previous stitches: then make purl stitches.

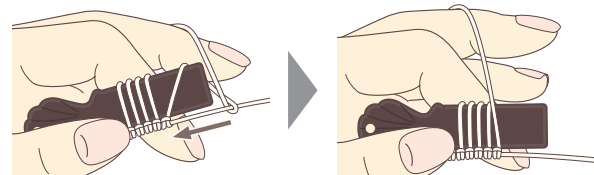

8104
Picot Gauge Set

7 pcs./pack	3 packs/box
Package Size	18.5 x 11 x 0.5 cm

Mini Weaving Looms

Simple and Easy!

Easily create woven motifs.
Many varieties of motifs result from different warp settings and yarn selections!

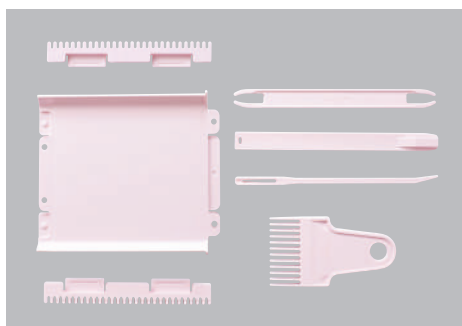
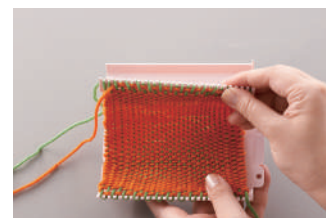
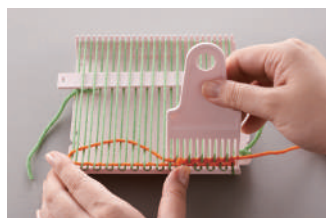
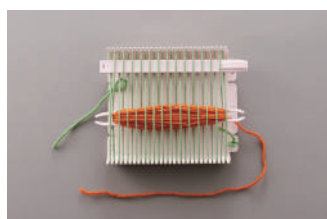

Finished size:
Approx. 12 cm sq.

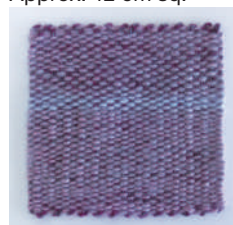

3176
Mini Weaving Loom (Single)

1 set/pack	3 packs/box
Package Size	25.7 x 16.5 x 3.7 cm

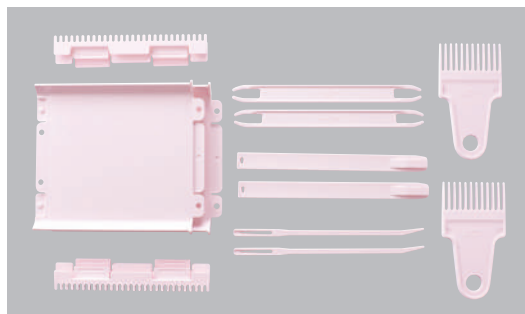

Finished size:
Approx. 25 cm width, 12 cm length

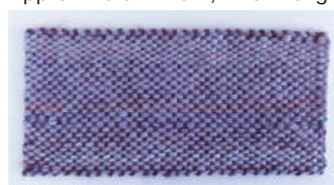

3177
Mini Weaving Loom (Double)

1 set/pack	3 packs/box
Package Size	25.7 x 16.5 x 3.7 cm

*Use the Weaving Loom also as a single.

Beading Loom

Enjoy making a variety of beaded art of many different sizes!

Beading made simple.

Perfectly assembled and gentle on even the most intricate projects. The sophisticated thread holder keeps the warp threads precisely in place and makes beading easy for beginners as well.



9910	
Clover Beading Loom	
0 51221 79910 5	
1 set/box	
Package Size	30 x 12 x 8 cm

* Package does not include beads or thread.



Weave wonderful accessories with this easy-to-use loom!

Shortest position

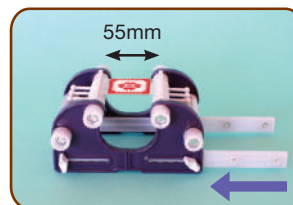

Longest position

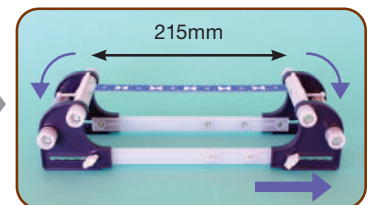

* Wind woven piece onto winding beam to create even longer works.

Stopper for preventing the warp threads coming undone.

Round beads (11/0) and small round beads can be used with this loom.

You can create different warp threads to match two different bead sizes.

Thread holder for fixing the warp threads in place
With a comb to align and straighten warp threads!

Easily and accurately adjust the thread length in units of 1cm depending on the size of each work.

- Create beautiful beaded artwork by weaving the ends of threads in with the beads for clean ends.
- You can bead up to 1.3m by winding the woven works onto the winding beam.
- Easily wind the beadwork horizontally with the outer dial.

Create everything from accessories to embellishments.







Rosette Makers

It is so easy to create beautiful Rosettes!
The parts set included will enable you to create a Rosette.

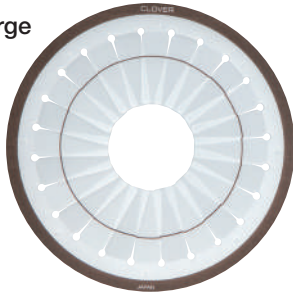
Large





		Large maker	
Finished size (approx.)		 8 cm	 9 cm
	Ribbon	Width 24 mm	36 mm
		Length 90 cm	110 cm



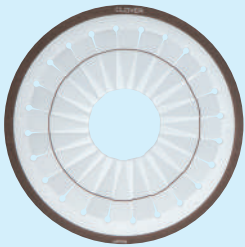

Contents

Plate 

Parts set

Center part  

Brooch base (felt)  

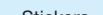
Pin back  

Stickers

8431
Rosette Maker(Large)









1 set/pack	3 packs/box
Package Size	22 x 14.5 x 1.1 cm



Parts set for the Rosette Maker(sold separately).



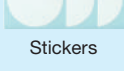

Contents

Center part    

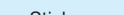
Brooch base (felt)    

Pin back    

Stickers





8432
Rosette Parts Set(Small)









1 set/pack	3 packs/box
Package Size	18 x 8 x 0.9 cm



Contents

Center part    

Brooch base (felt)    

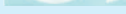
Pin back    

Stickers

8433
Rosette Parts Set(Large)



1 set/pack	3 packs/box
Package Size	19 x 8 x 1.1 cm



Memo

Index

5-in-1 Sliding Gauge	9506	51	Jumbo Point Protectors	3110/3112	28	S Straight Tailor's Awl	485/W	42
A Adapter Ball Tip	9104	73	Jumbo Stitch Ring Markers	354	26	Super Jumbo Tapestry Needle Set	3113	21
Adapter Iron Tip (Large)	9103	73	Jumbo Wonder Clips	3157/3186	66	Supersize 5-in-1 Sliding Gauge	9585	52
Adapter Slim Line Tip	9105	73	K "Kantan Couture Bead" Embroidery Tool	9900	75	Swatch Ruler and Needle Gauge	3200	29
Adjustable Ring Thimble	610	39	"Kantan Couture" Bead Embroidery Tool Needle Refill	9901	75	Sweet 'n Sharp Macaron	4130/4131	58
Adjustable Ring Thimble with Plate	611	39	Kanzashi Flower Maker	8483-8487	78	Swift Bead	2300	76
Air Erasable Marker	5030-5032	43	Knitting Accessory Set	3003	24	T Tapered Tailor's Awl	486/W	42
Amour Crochet Hook	1043-1059	18	Knitting Accessory Set for Beginners	3034	27	Tassel Maker	9940/9941	82
Amour Crochet Hook	1220-1226	19	Knitting Bobbin Set	332	24	Tatting Shuttle	479	85
Amour Crochet Hook Set	3674	18	Knitting Counter	336	23	Thread Clipper "KUROHA"	415	56
Amour Crochet Hook Set	3675	19	Knitting Needle Gauge	3147	29	Thread Cutter Pendant	454/455	56
Antique Yarn Threader	3114	22	Knitting Needle Tube Case	3120	28	Threader with Cutter "PETIT CUT"	478	55
Appliqué Pins	231	38	Knitting Register	328	23	Tracing Paper "Clover Chacopy"	434	46
B Ball Point Awl	876	42	L Lace Darning Needle Set	3168	21	Tracing Wheel (Blunt Edges)	481/W	41
Bamboo Knitting Needles "Takumi"	3011-3998	4	Locking Stitch Markers	353	27	Tracing Wheel (Serrated Edges)	480/W	41
Bamboo Knitting Repair Hooks	3009	30	Locking Stitch Markers with Clip	3165	27	Triangle Tailor's Chalk	432	46
Bamboo Marking Pins	3143	22	Loop Pressing Bars	4052	59	W Water Erasable Marker	515/516	43
Beading Needles	233	35	M Magnet Pin Caddy	4105	57	Water Soluble Pencil	5000-5003	44
Bias Tape Cutting Ruler (mm Gauge)	57-924	71	Marbled Glass Head Pins	2511	37	White Marking Pen (Fine)	517	43
Bias Tape Maker	464	71	Marking Pins for Knitting	325	22	Wonder Clips (10 pcs.)	3155/3180/3185	65
Black Gold Needles	4960-4983	32	Mesh Transfer Canvas	474	59	Wonder Clips (100 pcs.)	3159	66
Bodkin (2 Types)	4001	58	Mini Iron II™ "The Adapters"	8003/8004	73	Wonder Clips (50 pcs.)	3156/3183	65
Bracelet Maker	9943	80	Mini Knitting Counter	3118	23	Wonder Clips <Variety Pack> (26 pcs.)	3190	66
Buttonhole Cutter	484/W	41	Mini Weaving Loom	3176/3177	86	Wonder Knitter™	3101	79
C Cable Stitch Holders	330	24	Mini Wonder Clips	3188/3189	64	Wonder Pins	3210	36
Cable Stitch Holders (U-Shaped)	341	24	N Natural Fit Leather Thimbles	6028-6030	39	Y Yarn Cutter Pendant	3105/3106	23
Chaco Liner	469	46	Natural Wool Roving	7920-7939	84	Yarn Guide	348/349	23
Chaco Liner Pen Style	4710-4714	45	Needle Felting Mat	8910/8911	84			
Chaco Liner Refill	470	46	Needle Felting Tool	8900	83			
Chacopel Fine	418	44	Needle Felting Tool Refill Needle	8905/8906	83			
Chacopen Blue with Eraser (Water Erasable)	5013	43	No-Hassle Triangles Gauge	9579	60			
Circular Stitch Holder	3161/3162	25	O Open Sided Thimble	6017/6018	40			
Claw and Mat Cleaner	8919	84	P Patchwork Board "MULTI"	57-872	61			
Clip 'n Glide Bodkin	9582	58	Patchwork Pins	232	38			
Clover Beading Loom	9910	87	Patchwork Pins (Fine)	2507	38			
Clover Embroidery Hoop	8812/8813	75	Patchwork Scissors	493	68			
Clover Yarn Threader	3142	22	Patchwork Templates	494	60			
Coil Knitting Needle Holders	3122/3123	29	Pattern Chart Marker Set	3164	23			
Coin Thimble (Medium)	6014	39	Pen Style Needle Felting Tool	8901	83			
Curve Ruler with Mini Ruler	7704	50	Picot Gauge Set	8104	85			
Curved Tailor's Awl	4880	42	Point 2 Point Turner	7803	61			
D Darning Needle Set	339	21	Point Protectors	333	28			
Darning Needle Set (Bent Tip)	3121	21	Point Protectors and Stopper	3140	28			
Darning Needles with Latch Hook Eye	3160	21	Point Protectors for Circular Knitting Needles	3004/3005	28			
Desk Needle Threader	4071-4073	54	Point Protectors Petit	3141	28			
Design Pro Appliqué Mat	4095	59	Pom-Pom Maker	3124-3128	81			
Dome Threaded Needle Case	625	57	Pom-Pom Maker Set	3129	81			
Double Ended Tunisian Crochet Hook	1305/G-1308/J	20	Protect and Grip Thimble	6025-6027	40			
Double Needle Threader	462/NV	55	Q QUICK BIAS	700	60			
Double Sided Basting Tape	9505	59	"Quick Cut" Thread Cutter	7490	56			
Double Sided Thimble	616	39	Quick Locking Stitch Marker Set	3033	27			
Double Tracing Wheel	487/W	41	Quick Locking Stitch Markers	3030-3032	27			
Double-Ended Stitch Holders	351/352/3006	25	"QUICK" Yo-Yo Maker	8700-8708	77			
E Easy Loop Turner	472	59	Quilt Needle Threader	466	55			
Embroidery Stitching Tool	8800	74	Quilting Needles	468	33			
Embroidery Stitching Tool Needle Refill	8801-8804	74	Quilting Pins	2508	38			
Embroidery Stitching Tool Needle Threader	8810	74	Quilting Pins (Fine)	2509	38			
Embroidery Threader	8611	55	R Refill Cartridge for Chaco Liner Pen Style	4720-4724	45			
Eraser Pen	518	43	Roll & Press	7812	48			
F Finger Presser	495	49	Rosette Maker	8431	88			
Flexible Rubber Thimbles	6031/6032	40	Rosette Parts Set	8432/8433	88			
Flower Head Pins	2505/2506/2510	37	Rotary Blade Refills	7508-7515	70			
Flower Loom	3146	80	Rotary Cutter	7500-7503	69			
Fork Blocking Pins	3163	22	S Sashiko Needles	2007	35			
Fork Pins	240/2401	38	Sashiko Needles (Long Type)	2009	35			
French Knitter —Bead Jewelry Maker—	3100	79	Seam Marker Set	7707	52			
Fusible Bias Tape Maker	4011-4015	72	Seam Ripper	463,482/W	42			
Fusible Web	4041/4042	72	Self Threading Needles (Assorted)	2006	33			
G Gold Eye Appliqué Needles	497	33	Sewing Gauge	7705	51			
Gold Eye Chenille Needles	234	34	Slash Cutter	499	67			
Gold Eye Embroidery Needles	235	34	Sliding Gauge	7706	51			
Gold Eye Milliners Needles	236	35	Sliding Stitch Guide Foot	7709/9586	63			
Gold Eye Quilting Needles Between	496	33	Snag Repair Needles	2512	36			
Gold Eye Sharps Needles	237/10	35	Soft Jumbo Stitch Ring Markers	3108	26			
Gold Eye Tapestry Needles	238, 238/24	34	Soft Stitch Ring Markers	3107	26			
Graph Ruler	7702/7703	50	Soft Touch Crochet Hook	1001-1010	16			
H Hair Pin Lace Tool	3104	83	Soft Touch Crochet Hook	1020-1027	16			
Heart-Shaped Pins	9604	37	Soft Touch Thread Pick	4910	59			
"HERA"™ Marker	490/NV	49	Spare Bobbin Set	8107/8108	85			
"HERA"™ Marker For Appliqué & Sewing	4002	49	Split Ring Markers	347	26			
Hold It Precision Stiletto	7807	61	Stack 'n Store Bobbin Tower	9508	63			
Hot Hemmer	7700/7701	53	Stitch Dome	8830	76			
Huck Embroidery Needles	2012	34	Stitch Guide	7708/9584	62			
I Iron-On Transfer Pencil	5004/5005	44	Stitch Markers Triangle	3148-3150	26			
J Jumbo Cable Stitch Holder Set "U"	3008	24	Stitch Ring Markers	329	26			
Jumbo Darning Needle Set	340	21	Storage Case for Bobbin Tatting Shuttle	8109	85			
Jumbo Locking Stitch Markers	3109	27	Storage Case for Tatting Shuttle	8110	85			

Index

1001-1010	Soft Touch Crochet Hook	16	348/349	Yarn Guide	23	8109	Storage Case for Bobbin Tatting Shuttle	85
1020-1027	Soft Touch Crochet Hook	16	351/352	Double-Ended Stitch Holders	25	8110	Storage Case for Tatting Shuttle	85
1043-1059	Amour Crochet Hook	18	353	Locking Stitch Markers	27	8431	Rosette Maker	88
1220-1226	Amour Crochet Hook	19	354	Jumbo Stitch Ring Markers	26	8432/8433	Rosette Parts Set	88
1305/G-1308/U	Double Ended Tunisian Crochet Hook	20	3674	Amour Crochet Hook Set	18	8483-8487	Kanzashi Flower Maker	78
2006	Self Threading Needles (Assorted)	33	3675	Amour Crochet Hook Set	19	8611	Embroidery Threader	55
2007	Sashiko Needles	35	4001	Bodkin (2 Types)	58	8700-8708	"QUICK" Yo-Yo Maker	77
2009	Sashiko Needles (Long Type)	35	4002	"HERA"™ Marker For Appliqué & Sewing	49	876	Ball Point Awl	42
2012	Huck Embroidery Needles	34	4011-4015	Fusible Bias Tape Maker	72	8800	Embroidery Stitching Tool	74
2300	Swift Bead	76	4041/4042	Fusible Web	72	8801-8804	Embroidery Stitching Tool Needle Refill	74
231	Appliqué Pins	38	4052	Loop Pressing Bars	59	8810	Embroidery Stitching Tool Needle Threader	74
232	Patchwork Pins	38	4071-4073	Desk Needle Threader	54	8812/8813	Clover Embroidery Hoop	75
233	Beading Needles	35	4095	Design Pro Appliqué Mat	59	8830	Stitch Dome	76
234	Gold Eye Chenille Needles	34	4105	Magnet Pin Caddy	57	8900	Needle Felting Tool	83
235	Gold Eye Embroidery Needles	34	415	Thread Clipper "KUROHA"	56	8901	Pen Style Needle Felting Tool	83
236	Gold Eye Milliners Needles	35	418	Chacopel Fine	44	8905/8906	Needle Felting Tool Refill Needle	83
237/10	Gold Eye Sharps Needles	35	4130/4131	Sweet 'n Sharp Macaron	58	8910/8911	Needle Felting Mat	84
238, 238/24	Gold Eye Tapestry Needles	34	432	Triangle Tailor's Chalk	46	8919	Claw and Mat Cleaner	84
240/2401	Fork Pins	38	434	Tracing Paper "Clover Chacopy"	46	9103	Adapter Iron Tip (Large)	73
2505	Flower Head Pins 0.55 mm	37	454/455	Thread Cutter Pendant	56	9104	Adapter Ball Tip	73
2506	Flower Head Pins (Boxed)	37	462/NV	Double Needle Threader	55	9105	Adapter Slim Line Tip	73
2507	Patchwork Pins (Fine)	38	463	Seam Ripper	42	9505	Double Sided Basting Tape	59
2508	Quilting Pins	38	464	Bias Tape Maker	71	9506	5-in-1 Sliding Gauge	51
2509	Quilting Pins (Fine)	38	466	Quilt Needle Threader	55	9508	Stack 'n Store Bobbin Tower	63
2510	Flower Head Pins 0.45 mm	37	468	Quilting Needles	33	9579	No-Hassle Triangles Gauge	60
2511	Marbled Glass Head Pins	37	469	Chaco Liner	46	9582	Clip 'n Glide Bodkin	58
2512	Snag Repair Needles	36	470	Chaco Liner Refill	46	9584	Stitch Guide	62
3003	Knitting Accessory Set	24	4710-4714	Chaco Liner Pen Style	45	9585	Supersize 5-in-1 Sliding Gauge	52
3004/3005	Point Protectors for Circular Knitting Needles	28	4720-4724	Refill Cartridge for Chaco Liner Pen Style	45	9586	Sliding Stitch Guide Foot	63
3006	Double-Ended Stitch Holders (Medium)	25	472	Easy Loop Turner	59	9604	Heart-Shaped Pins	37
3008	Jumbo Cable Stitch Holder Set "U"	24	474	Mesh Transfer Canvas	59	9900	"Kantan Couture" Bead Embroidery Tool	75
3009	Bamboo Knitting Repair Hooks	30	478	Threader with Cutter "PETIT CUT"	55	9901	"Kantan Couture" Bead Embroidery Tool Needle Refill	75
3011-3998	Bamboo Knitting Needles "Takumi"™	4	479	Tatting Shuttle	85	9910	Clover Beading Loom	87
3030-3032	Quick Locking Stitch Markers	27	480/W	Tracing Wheel (Serrated Edges)	41	9940/9941	Tassel Maker	82
3033	Quick Locking Stitch Marker Set	27	481/W	Tracing Wheel (Blunt Edges)	41	9943	Bracelet Maker	80
3034	Knitting Accessory Set for Beginners	27	482/W	Seam Ripper	42			
3100	French Knitter —Bead Jewelry Maker—	79	484/W	Buttonhole Cutter	41			
3101	Wonder Knitter™	79	485/W	Straight Tailor's Awl	42			
3104	Hair Pin Lace Tool	83	486/W	Tapered Tailor's Awl	42			
3105/3106	Yarn Cutter Pendant	23	487/W	Double Tracing Wheel	41			
3107	Soft Stitch Ring Markers	26	4880	Curved Tailor's Awl	42			
3108	Soft Jumbo Stitch Ring Markers	26	490/NV	"HERA"™ Marker	49			
3109	Jumbo Locking Stitch Markers	27	4910	Soft Touch Thread Pick	59			
3110/3112	Jumbo Point Protectors	28	493	Patchwork Scissors	68			
3113	Super Jumbo Tapestry Needle Set	21	494	Patchwork Templates	60			
3114	Antique Yarn Threader	22	495	Finger Presser	49			
3118	Mini Knitting Counter	23	496	Gold Eye Quilting Needles Between	33			
3120	Knitting Needle Tube Case	28	4960-4983	Black Gold Needles	32			
3121	Darning Needle Set (Bent Tip)	21	497	Gold Eye Appliqué Needles	33			
3122/3123	Coil Knitting Needle Holders	29	499	Slash Cutter	67			
3124-3128	Pom-Pom Maker	81	5000-5003	Water Soluble Pencil	44			
3129	Pom-Pom Maker Set	81	5004/5005	Iron-On Transfer Pencil	44			
3140	Point Protectors and Stopper	28	5013	Chacopen Blue with Eraser (Water Erasable)	43			
3141	Point Protectors Petit	28	5030-5032	Air Erasable Marker (Purple)	43			
3142	Clover Yarn Threader	22	515/516	Water Erasable Marker	43			
3143	Bamboo Marking Pins	22	517	White Marking Pen (Fine)	43			
3146	Flower Loom	80	518	Eraser Pen	43			
3147	Knitting Needle Gauge	29	57-872	Patchwork Board "MULTI"	61			
3148-3150	Stitch Markers Triangle	26	57-924	Bias Tape Cutting Ruler (mm Gauge)	71			
3155/3156	Wonder Clips	65	6014	Coin Thimble (Medium)	39			
3157	Jumbo Wonder Clips (24 pcs.)	66	6017/6018	Open Sided Thimble	40			
3159	Wonder Clips (100 pcs.)	66	6025-6027	Protect and Grip Thimble	40			
3160	Darning Needles with Latch Hook Eye	21	6028-6030	Natural Fit Leather Thimbles	39			
3161/3162	Circular Stitch Holder	25	6031/6032	Flexible Rubber Thimbles	40			
3163	Fork Blocking Pins	22	610	Adjustable Ring Thimble	39			
3164	Pattern Chart Marker Set	23	611	Adjustable Ring Thimble with Plate	39			
3165	Locking Stitch Markers with Clip	27	616	Double Sided Thimble	39			
3168	Lace Darning Needle Set	21	625	Dome Threaded Needle Case	57			
3176/3177	Mini Weaving Loom	86	700	QUICK BIAS	60			
3180	Wonder Clips (Neon Green)	65	7490	"Quick Cut" Thread Cutter	56			
3183/3185	Wonder Clips (Assortment)	65	7500-7503	Rotary Cutter	69			
3186	Jumbo Wonder Clips (12 pcs.)	66	7508-7515	Rotary Blade Refills	70			
3188/3189	Mini Wonder Clips	64	7700/7701	Hot Hemmer	53			
3190	Wonder Clips <Variety Pack> (26 pcs.)	66	7702/7703	Graph Ruler	50			
3200	Swatch Ruler and Needle Gauge	29	7704	Curve Ruler with Mini Ruler	50			
3210	Wonder Pins	36	7705	Sewing Gauge	51			
325	Marking Pins for Knitting	22	7706	Sliding Gauge	51			
328	Knitting Register	23	7707	Seam Marker Set	52			
329	Stitch Ring Markers	26	7708	Stitch Guide	62			
330	Cable Stitch Holders	24	7709	Sliding Stitch Guide Foot	63			
332	Knitting Bobbin Set	24	7803	Point 2 Point Turner	61			
333	Point Protectors	28	7807	Hold It Precision Stiletto	61			
336	Knitting Counter	23	7812	Roll & Press	48			
339	Darning Needle Set	21	7920-7939	Natural Wool Roving	84			
340	Jumbo Darning Needle Set	21	8003/8004	Mini Iron II™ "The Adapters"	73			
341	Cable Stitch Holders (U-Shaped)	24	8104	Picot Gauge Set	85			
347	Split Ring Markers	26	8107/8108	Spare Bobbin Set	85			

www.clover-mfg.com

info@clover-mfg.com

CLOVER MFG. CO., LTD.

3-15-5 Nakamichi, Higashinari-ku, Osaka, Japan

897291

JAN 2022
170KMT